



## DECLARATION OF PERFORMANCE



DoP: 0152

for fischer frame fixing SXR/SXRL (Plastic anchors for use in concrete and masonry) – EN

1. Unique identification code of the product-type: **DoP: 0152**
2. Intended use/es: **For use in systems, such as façade systems, for fixing or supporting elements which contribute to the stability of the systems, see appendix, especially Annexes B 1 to B 12**
3. Manufacturer: **fischerwerke GmbH & Co. KG, Klaus-Fischer-Straße 1, 72178 Waldachtal, Germany**
4. Authorised representative: --
5. System/s of AVCP: **2+**
6. European Assessment Document: **EAD 330284-00-0604**

European Technical Assessment: **ETA-07/0121; 2018-12-13**

Technical Assessment Body: **DIBt**

Notified body/ies: **1343 – MPA Darmstadt**

7. Declared performance/s:

### Mechanical resistance and stability (BWR 1)

- **Resistance to steel failure under tension loading: See appendix, especially Annex C 1**
- **Resistance to steel or polymer failure under shear loading: See appendix, especially Annex C 1**
- **Resistance to pull-out or concrete failure or polymer failure under tension loading (base material group a): See appendix, especially Annexes C 1**
- **Resistance in any load direction without lever arm (base material group b, c and d): See appendix, especially Annexes C 3 to C 20**
- **Edge distance and spacing (base material group a): See appendix, especially Annex B 3**
- **Edge distance and spacing (base material group b, c and d): See appendix, especially Annex B 4**
- **Displacements under short-term and long-term loading: See appendix, especially Annex C 2**

### Safety in case of fire (BWR 2)

- **Reaction to fire: Anchorages satisfy requirements for Class A 1**
- **Resistance to fire: See appendix, especially Annex C 2**

8. Appropriate Technical Documentation and/or Specific Technical Documentation: ---

The performance of the product identified above is in conformity with the set of declared performance/s. This declaration of performance is issued, in accordance with Regulation (EU) No 305/2011, under the sole responsibility of the manufacturer identified above.

Signed for and on behalf of the manufacturer by:

Andreas Bucher, Dipl.-Ing.

Wolfgang Hengesbach, Dipl.-Ing., Dipl.-Wirtsch.-Ing.

Tumlingen, 2018-12-20

- This DoP has been prepared in different languages. In case there is a dispute on the interpretation the english version shall always prevail.
- The Appendix includes voluntary and complementary information in English language exceeding the (language-neutrally specified) legal requirements.

**Specific Part**

**1 Technical description of the product**

The fischer frame fixing in the range SXR 8, SXRL 8, SXR 10, SXRL 10 and SXRL 14 is a plastic anchor consisting of a plastic sleeve made of polyamide and an accompanying specific screw of galvanised steel, of galvanised steel with an additional Duplex-coating or of stainless steel.

The plastic sleeve is expanded by screwing in the specific screw which presses the sleeve against the wall of the drilled hole.

The product description is given in Annex A.

**2 Specification of the intended use in accordance with the applicable European Assessment Document**

The performances given in Section 3 are only valid if the anchor is used in compliance with the specifications and conditions given in Annex B.

The verifications and assessment methods on which this European Technical Assessment is based lead to the assumption of a working life of the anchors of at least 50 years. The indications given on the working life cannot be interpreted as a guarantee given by the producer, but are to be regarded only as a means for choosing the right products in relation to the expected economically reasonable working life of the works.

**3 Performance of the product and references to the methods used for its assessment**

**3.1 Mechanical resistance and stability (BWR 1)**

Essential characteristic	Performance
Resistance to steel failure under tension loading	See Annex C 1
Resistance to steel or polymer failure under shear loading	See Annex C 1
Resistance to pull-out or concrete failure or polymer failure under tension loading (base material group a)	See Annex C 1
Resistance in any load direction without lever arm (base material group b, c and d)	See Annexes C 3 - C 20
Edge distance and spacing (base material group a)	See Annex B 3
Edge distance and spacing (base material group b, c and d)	See Annex B 4
Displacements under short-term and long-term loading	See Annex C 2

**3.2 Safety in case of fire (BWR 2)**

Essential characteristic	Performance
Reaction to fire	Class A 1
Resistance to fire	See Annex C 2

**4 Assessment and verification of constancy of performance (AVCP) system applied, with reference to its legal base**

In accordance with the European Assessment Document EAD 330284-00-0604 the applicable European legal act is: 97/463/EC.

The system to be applied is: 2+

**SXR**

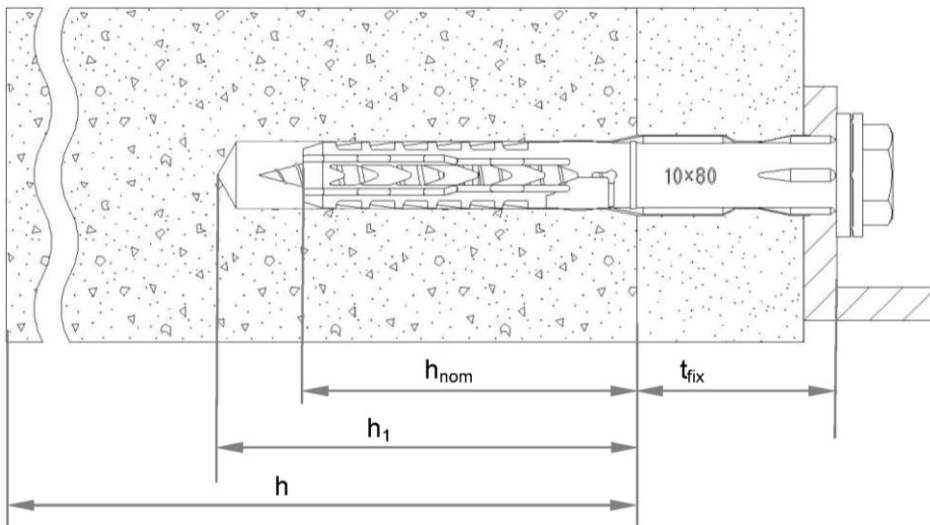

**SXRL (e.g. with  $h_{nom2}$ )**

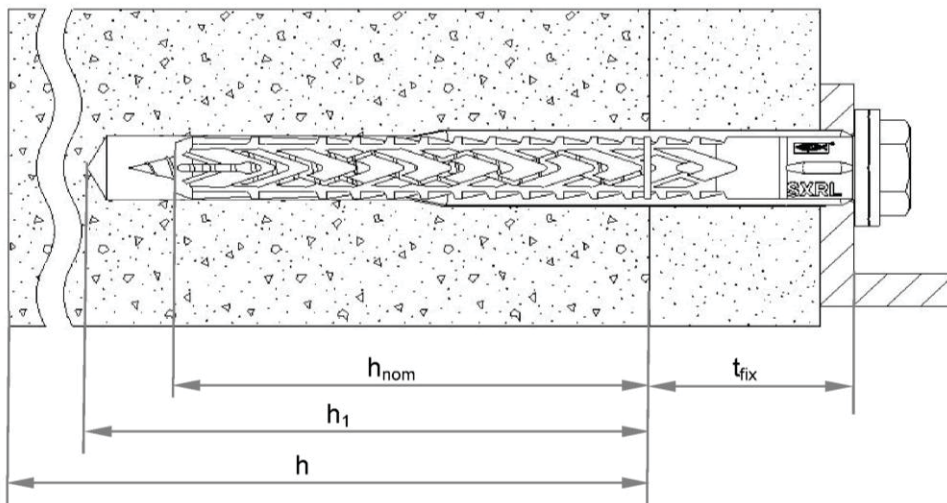

**Legend**

- $h_{nom}$  = overall plastic anchor embedment depth in the base material
- $h_1$  = depth of drill hole to deepest point
- $h$  = thickness of member (wall)
- $t_{fix}$  = thickness of fixture and / or non-load bearing layer

fischer frame fixing SXR / SXRL

**Product description**  
Installed anchor

**Annex A 1**

**Anchor sleeves – flat collar versions of SXR and SXRL**

**SXR-version**

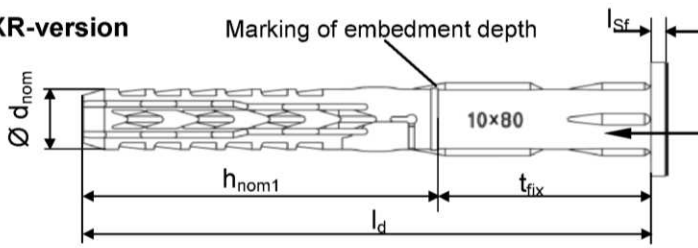

Marking:  
 Brand  
 Anchor type  
 Size  
 e.g. SXR 10x80  
 e.g. SXRL 14x100

**SXRL-version**

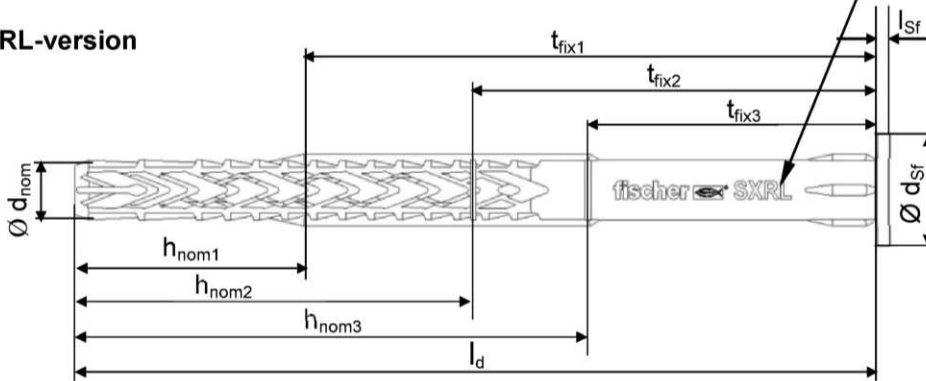

Countersunk sleeve version also available for both versions

**Countersunk screws**

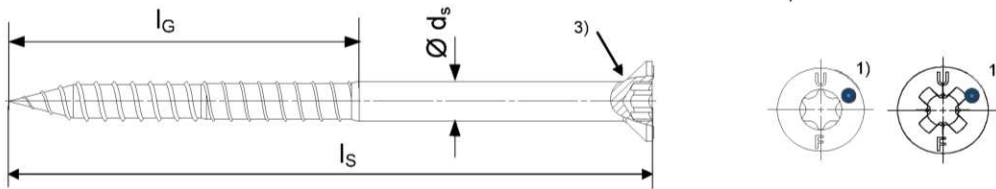

**Hexagonal screw with washer**

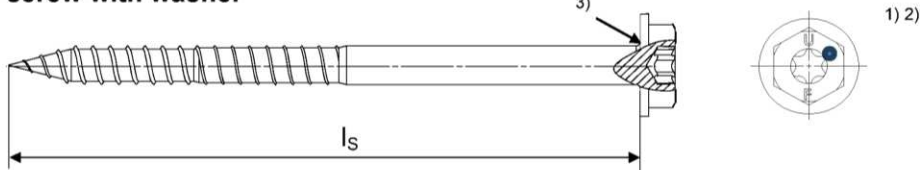

**Hexagonal screw**



**Stud screw**

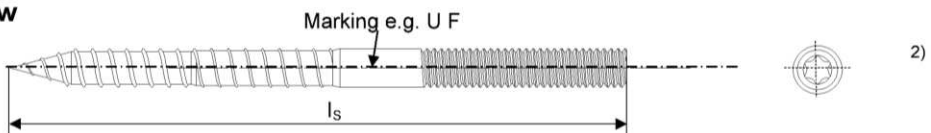

- 1) Additional marking for the special screw, stainless steel version: „e.g. A4“.
- 2) Internal driving feature for Torx bit is optional for hexagonal head and for stud screw
- 3) Optional additional version with underhead ribs

**fischer frame fixing SXR / SXRL**

**Product description**  
 Anchor types / special screws

**Annex A 2**

Table A3.1: Dimensions

Anchor type	Anchor sleeve								Special screw			
	$h_{nom1}$ [mm]	$h_{nom2}$ [mm]	$h_{nom3}$ [mm]	$\varnothing d_{nom}$ [mm]	$t_{fix}$ [mm]	min. $l_d$ [mm]	max. $l_d$ [mm]	$l_{sf}^{1)}$ [mm]	$\varnothing d_{sf}$ [mm]	$\varnothing d_s$ [mm]	$l_G$ [mm]	$l_s$ [mm]
SXR 8	50	-	-	8	$\geq 1$	51	360	1,8	> 15,0	6,0	$\geq 55$	$\geq l_d + 6$
SXRL 8	50	70	90	8	$\geq 1$	51	360	1,8	> 15,0	6,0	$\geq 55$	$\geq l_d + 6$
SXR 10	50	-	-	10	$\geq 1$	51	360	2,2	> 18,5	7,0	$\geq 57$	$\geq l_d + 7$
SXRL 10	50 <sup>2)</sup>	70	90	10	$\geq 1$	51	360	2,2	> 18,5	7,0	$\geq 57$	$\geq l_d + 7$
SXRL 14	-	70	90	14	$\geq 1$	71	600	3,1	> 24,0	9,6	$\geq 63$	$\geq l_d + 10$

<sup>1)</sup> Only valid for flat collar version

<sup>2)</sup> Marking optional

Table A3.2: Materials

Name	Material
Anchor sleeve	Polyamide, PA6, colour grey
Special screw	<ul style="list-style-type: none"> <li>- Steel gvz A2G or A2F acc. to EN ISO 4042:2001</li> <li style="text-align: center;"><u>or</u></li> <li>- Steel gvz A2G or A2F acc. to EN ISO 4042:2001+ Duplex-coating type Delta-Seal in three layers (total layer thickness <math>\geq 6 \mu\text{m}</math>)</li> <li style="text-align: center;"><u>or</u></li> <li>- Stainless steel acc. to EN 10 088-3:2014, e.g. 1.4301, 1.4567 (A2)</li> <li style="text-align: center;"><u>or</u></li> <li>- Stainless steel acc. to EN 10 088-3:2014, e.g. 1.4401, 1.4571, 1.4578, 1.4362 (A4)</li> </ul>

fischer frame fixing SXR / SXRL

**Product description**  
Dimensions and materials

**Annex A 3**

**Specifications of intended use**

**Anchorage subject to:**

- Static and quasi-static loads.

**Base materials:**

- Reinforced or unreinforced normal weight concrete with strength classes  $\geq$  C12/15 (use category "a"), in accordance with EN 206:2013.
- Thin-walled concrete components (e.g. weather shells)  $\geq$  40 mm thickness.
- Solid brick masonry (use category "b"), in accordance with to Annex C3 – C7.  
Note: The characteristic resistance is also valid for larger brick sizes and higher compressive strength of the masonry unit.
- Hollow brick masonry (use category "c"), in accordance with to Annex B6 – B12 and C7 – C19.
- Autoclaved aerated concrete (use category "d"), in accordance with Annex C20.
- Mortar strength class of the masonry  $\geq$  M2,5 in accordance with EN 998-2:2010.
- For other comparable base materials of the base material group "a", "b", "c" and "d" the characteristic resistance of the anchor may be determined by job site tests in accordance with TR 051:2018-04.

**Temperature Range:**

SXR 8 and 10 and SXRL 8

- c: - 40 °C to 50 °C (max. short term temperature + 50 °C and max long term temperature + 30 °C)
- b: - 40 °C to 80 °C (max. short term temperature + 80 °C and max long term temperature + 50 °C)

SXRL 10 and 14

- c: - 20 °C to 50 °C (max. short term temperature + 50 °C and max long term temperature + 30 °C)
- b: - 20 °C to 80 °C (max. short term temperature + 80 °C and max long term temperature + 50 °C)

**Use conditions (Environmental conditions):**

- Structures subject to dry internal conditions: Special screw made of zinc coated steel, stainless steel A2 or A4.
- The specific screw made of galvanised steel or galvanised steel with an additional Duplex-coating may also be used in structures subject to external atmospheric exposure, if the area of the head of the screw is protected against moisture and driving rain after mounting of the fixing unit in this way, that intrusion of moisture into the anchor shaft is prevented. Therefore there shall be an external cladding or a ventilated rainscreen mounted in front of the head of the screw and the head of the screw itself shall be coated with a soft plastic, permanently elastic bitumen-oil-combination coating (e.g. undercoating or body cavity protection for cars).
- Structures subject to external atmospheric exposure (including industrial and marine environment) and to permanently damp internal condition, if no particular aggressive conditions exist: Special screw made of stainless steel A4.

Note: Particular aggressive conditions are e.g. permanent, alternating immersion in seawater or the splash zone of seawater, chloride atmosphere of indoor swimming pools or atmosphere with extreme chemical pollution (e.g. in desulphurization plants or road tunnels where de-icing materials are used).

**Design:**

- The anchorages are to be designed in accordance with TR 064:2018-05 under the responsibility of an engineer experienced in anchorages and masonry work.
- Verifiable calculation notes and drawings shall be prepared taking account of the loads to be anchored, the nature and strength of the base materials and the dimensions of the anchorage members as well as of the relevant tolerances. The position of the anchor is indicated on the design drawings.
- Fasteners are only to be used for multiple use for non-structural application, in accordance with TR 064:2018-05.

**Installation:**

- Hole drilling by the drilling method in accordance with Annex C3 – C20 for use categories "b", "c" and "d".
- Anchor installation carried out by appropriately qualified personnel and under the supervision of the person responsible for technical matters of the site.
- Installation temperature from SXR 8/10, SXRL 8 and SXRL 14: - 5 °C to + 40 °C  
SXRL 10: - 20 °C to + 40 °C
- Exposure to UV due to solar radiation of the not protected anchor  $\leq$  6 weeks.
- No ingress of water in the borehole at temperatures  $<$  0 °C

fischer frame fixing SXR / SXRL

Anhang B 1

Intended use  
Specifications

**Table B2.1: Installation parameters**

Anchor type		SXR 8	SXRL 8	SXR 10	SXRL 10	SXRL 14
Drill hole diameter	$d_0 =$ [mm]	8	8	10	10	14
Cutting diameter of drill bit	$d_{cut} \leq$ [mm]	8,45	8,45	10,45	10,45	14,45
Overall plastic anchor embedment depth in the base material <sup>1) 2)</sup>	$h_{nom1} \geq$ [mm]	50	50	50	50	-
	$h_{nom2} \geq$ [mm]	-	70	-	70	70
	$h_{nom3} \geq$ [mm]	-	90	-	90	90
Depth of drill hole to deepest point <sup>1)</sup>	$h_{1,1} \geq$ [mm]	60	60	60	60	-
	$h_{1,2} \geq$ [mm]	-	80	-	80	85
	$h_{1,3} \geq$ [mm]	-	100	-	100	105
Diameter of clearance hole in the fixture	$d_f \leq$ [mm]	8,5	9,5	10,5/12,5 <sup>3)</sup>	10,5/12,5 <sup>3)</sup>	15,4

<sup>1)</sup> See Annex A1.

<sup>2)</sup> For hollow and perforated masonry: If the embedment depth is higher than  $h_{nom}$  given in the Table B2.1, job site tests have to be carried out in accordance with TR 051:2018-04.

<sup>3)</sup> See Table C2.1.

**Table B2.2: Assignment of  $h_{nom}$ ,  $l_d$  and  $t_{fix}$  for use in thin concrete slabs (e.g. weather resistant shells of external wall panels) and pre-stressed concrete core slabs**

Anchor type	SXR 10 / SXRL 10			
	$l_d$		$h_{nom} \geq 50$ mm	
	SXR	SXRL	$t_{fix, min}$	$t_{fix, max}$
Use category "a"	52	-	1	2
	60	60	1	10
	80	80	21	30
	100	100	41	50
	120	120	61	70
	140	140	81	90
	160	160	101	110
	180	180	121	130
	200	200	141	150
	230	230	171	180
	260	260	201	210
	-	290	231	240
	[mm]			

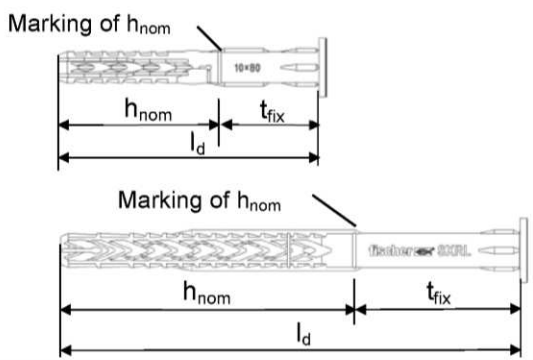

**Table B2.3: Installation parameters for use in pre-stressed hollow concrete core slabs**

Anchor type	SXRL 10			
	Mirror thickness	$d_b$	$\geq$ [mm]	30
	Overall plastic anchor embedment depth in the base material	$h_{nom}$	[mm]	50 to 59

fischer frame fixing SXR / SXRL

**Intended use**

Installation parameters, parameters for use in thin skins (weather resistant concrete skins of external wall panels) and pre-stressed hollow concrete core slabs

**Anhang B 2**



**Table B3.1: Minimum thickness of member, edge distance and spacing in concrete**

Anchor Type	$h_{nom} \geq$ [mm]	Concrete Strength class	Min. thickness of member $h_{min}$ [mm]	Characteristic edge distance $c_{cr}$ [mm]	Characteristic spacing $s_{cr}$ [mm]	Min. spacing and edge distances <sup>1)</sup> [mm]
SXR 8	50	$\geq$ C16/20	100	50	65	$s_{min} = 50$ for $c \geq 50$ $c_{min} = 50$ for $s \geq 50$
		C12/15		70	70	$s_{min} = 70$ for $c \geq 70$ $c_{min} = 70$ for $s \geq 70$
SXRL 8	50	$\geq$ C16/20	80	60	75	$s_{min} = 60$ for $c \geq 60$ $c_{min} = 60$ for $s \geq 60$
		C12/15		85	90	$s_{min} = 85$ for $c \geq 85$ $c_{min} = 85$ for $s \geq 85$
	70	$\geq$ C16/20	100	60	90	$s_{min} = 60$ for $c \geq 60$ $c_{min} = 60$ for $s \geq 60$
		C12/15		85	105	$s_{min} = 85$ for $c \geq 85$ $c_{min} = 85$ for $s \geq 85$
SXR 10	50	$\geq$ C16/20	100 <sup>4)</sup>	100	90	$s_{min} = 50$ for $c \geq 150$ $c_{min} = 60$ for $s \geq 70$
		C12/15		140	100	$s_{min} = 70$ for $c \geq 210$ $c_{min} = 85$ for $s \geq 100$
SXRL 10	50	$\geq$ C16/20	100 <sup>4)</sup>	100	105	$s_{min} = 50$ for $c \geq 100$ $c_{min} = 50$ for $s \geq 125$
		C12/15		140	120	$s_{min} = 70$ for $c \geq 140$ $c_{min} = 70$ for $s \geq 175$
	70 <sup>2)</sup>	$\geq$ C16/20		100	105	$s_{min} = 50$ for $c \geq 100$ $c_{min} = 50$ for $s \geq 125$
		C12/15		140	120	$s_{min} = 70$ for $c \geq 140$ $c_{min} = 70$ for $s \geq 175$
SXRL 14	70 <sup>3)</sup>	$\geq$ C16/20	110	100	120	$s_{min} = 60$ for $c \geq 100$ $c_{min} = 60$ for $s \geq 125$
		C12/15		140	135	$s_{min} = 85$ for $c \geq 140$ $c_{min} = 85$ for $s \geq 175$

- 1) Intermediate values by linear interpolation.
- 2) Values valid for reinforced concrete.  
Please note: Values for non-reinforced concrete are  $h_{min} = 110$  mm and  $c_{min} = s_{min} = 80$  mm for concrete  $\geq$  C16/20 and  $c_{min} = s_{min} = 110$  mm for C12/15.
- 3) Please note: Values for non-reinforced concrete are  $h_{min} = 110$  mm and  $c_{min} = 100$  and  $s_{min} = 80$  mm for concrete  $\geq$  C16/20 and  $c_{min} = 140$  and  $s_{min} = 110$  mm for C12/15.
- 4) Also valid for thin concrete slabs  $h \geq 40$  mm,  $h_{nom} = 50$  mm to 59 mm

Fixing points with a spacing  $a \leq s_{cr}$  are considered as a group with a max. characteristic resistance  $N_{RK,p}$  acc. to Table C1.3. For a spacing  $a > s_{cr}$  the anchors are considered as single anchors, each with a characteristic resistance  $N_{RK,p}$  acc. to Table C1.3.

**Scheme of distance and spacing in concrete**

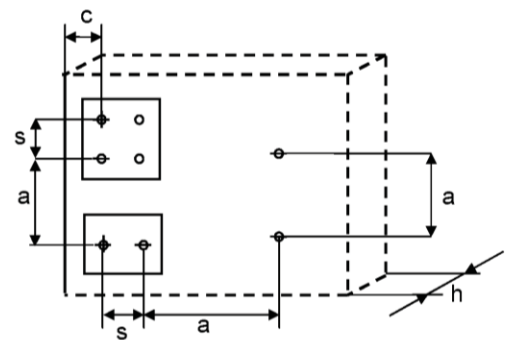

**fischer frame fixing SXR / SXRL**

**Intended use**  
Edge distances and spacings for use in concrete

**Anhang B 3**

**Table B4.1: Minimum thickness of member, edge distance and spacing in masonry**

Anchor type	SXR 8	SXRL 8	SXR 10	SXRL 10	SXRL 14
Minimum thickness of member $h_{min}$ [mm]	100	115	100	110	115
<b>Single anchor</b>					
Minimum spacing $a_{min}$ [mm]	250	250	250	250	250
Minimum edge distance $c_{min}$ [mm]	100	100	100	100	100
<b>Anchor group</b>					
Minimum spacing perpendicular to free edge $s_{1,min}$ [mm]	100	100	100	100	100
Minimum spacing parallel to free edge $s_{2,min}$ [mm]	100	100	100	100	100
Minimum edge distance $c_{min}$ [mm]	100	100	100	100	100
Distance between anchor groups and / or single anchors $a$ [mm]	250				

**Scheme of distance and spacing in masonry and aerated concrete AAC**

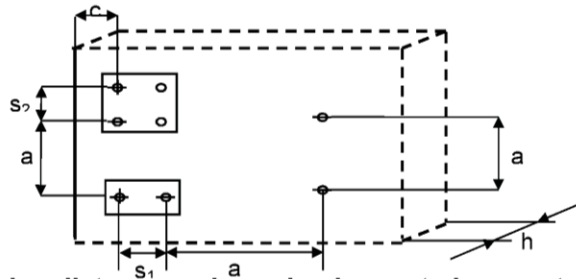

**Table B4.2: Minimum thickness of member, edge distance and spacing in aerated concrete AAC**

Anchor type	SXRL 8	SXR 10	SXRL 10	SXRL 14
Compressive strength $f_b$ [N/mm <sup>2</sup> ]	≥ 2 to < 6	≥ 6	≥ 2	≥ 2 to < 4
Nominal embedment depth $h_{nom} \geq$ [mm]	70 and 90	50	70 90	70 90 70 90
Minimum thickness of member $h_{min}$ [mm]	175	100	100 120	175 300
<b>Single anchor</b>				
Minimum spacing $a_{min}$ [mm]	250	250	250	250
Minimum edge distance $c_{min}$ [mm]	60	80	100	120
<b>Anchor group</b>				
Minimum spacing perpendicular to free edge $s_{1,min}$ [mm]	80	110	200	100 / 120 <sup>1)</sup>
Minimum spacing parallel to free edge $s_{2,min}$ [mm]	80	110	400	100 / 120 <sup>1)</sup>
Minimum edge distance $c_{min}$ [mm]	90	110	100	120
Distance between anchor groups and / or single anchors $a$ [mm]	250 <sup>2)</sup>			

<sup>1)</sup> Valid for AAC ≥ 600 kg/m<sup>3</sup>

<sup>2)</sup> For SXR 10  $a \geq 400$  mm

**fischer frame fixing SXR / SXRL**

**Intended use**

Edge distances and spacing for use in masonry and in autoclaved aerated concrete AAC

**Anhang B 4**

**Installation instructions (the following pictures show fixing through timber)**

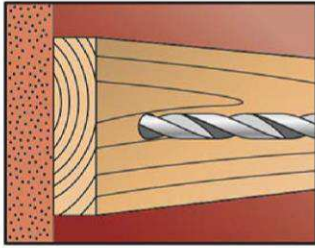

1. Drill the bore hole acc. to Table B2.1 using the drill method described in the corresponding Annex C.

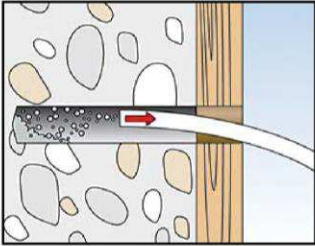

2. Use category „a“, „b“, „d“: Remove dust from borehole.

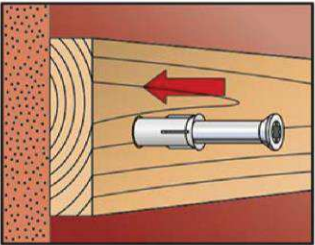

3. Insert anchor (screw and plug) by using a hammer until the collar of the plastic sleeve is flush with the surface of the fixture.

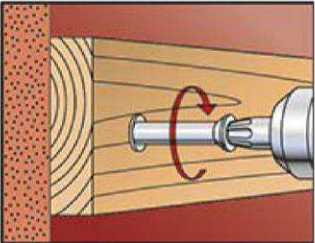

4. The screw is screwed-in until the head of the screw touches the sleeve. The anchor is correctly mounted, when the head of the screw fits tight on the surface and cannot be screwed-in any further.

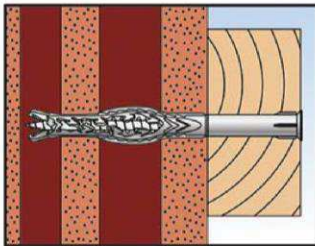

5. Correctly installed anchor in hollow masonry.

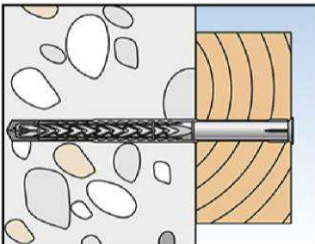

6. Correctly installed anchor in concrete.

**fischer frame fixing SXR / SXRL**

**Intended use**  
Installation instructions

**Anhang B 5**

**Table B6.1: Summary of hollow and perforated bricks – see Annex C 7 – C 9**

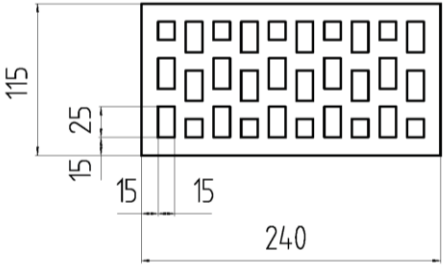
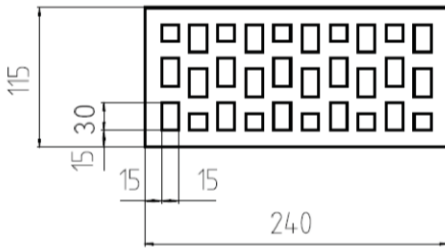
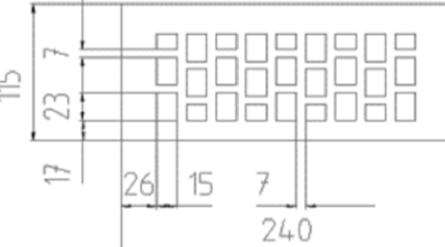
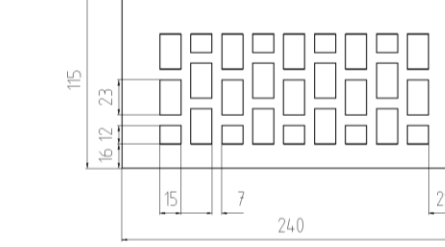
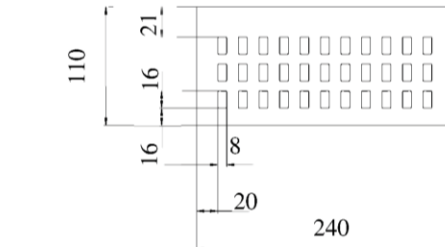
Brick No./ Country	Dimensions	Brick drawing	See Annex
S1/DE	2 DF 240 x 115 x 113 mm		C 7
S2/DE	2 DF 240 x 115 x 113 mm		C 8
S3/DE	NF 240 x 115 x 71 mm		C 8
S4/DE	2 DF 240 x 115 x 113 mm		C 8
S5/DE	DF 240 x 110 x 52 mm		C 9

**fischer frame fixing SXR / SXRL**

**Intended use**  
Summary of hollow and perforated bricks

**Anhang B 6**

**Table B7.1: Summary of hollow and perforated bricks – see Annex C 9 – C 10**

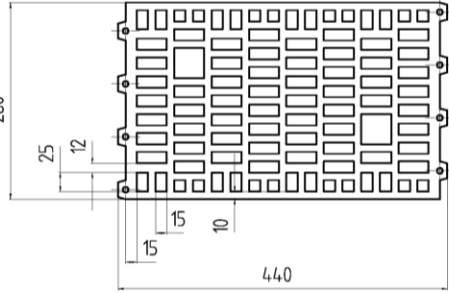
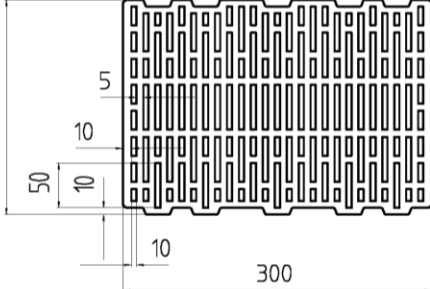
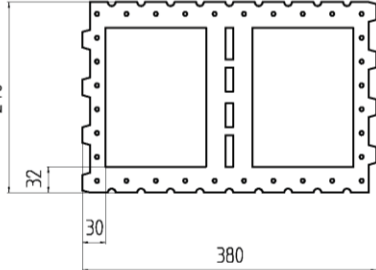
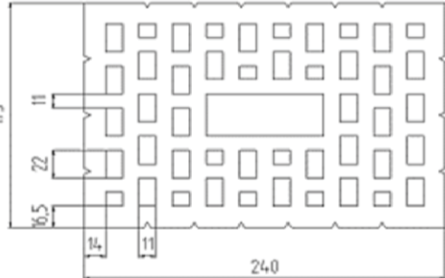
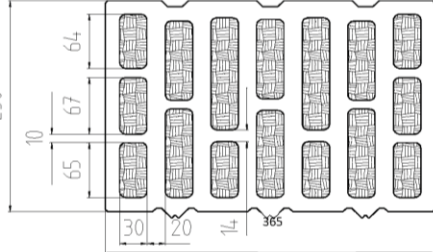
Brick No./ Country	Dimensions	Brick drawing	See Annex
S6/DE	10 DF 440 x 240 x 260 mm		C 9
S7/DE	10 DF 300 x 240 x 240 mm		C 9
S8/DE	12 DF 380 x 240 x 240 mm		C 10
S9/DE	3 DF 240 x 175 x 113 mm		C 10
S10/DE	12 DF 365 x 250 x 240 mm		C 10

**fischer frame fixing SXR / SXRL**

**Intended use**  
Summary of hollow and perforated bricks

**Anhang B 7**

**Table B8.1: Summary of hollow and perforated bricks – see Annex C11 – C12**

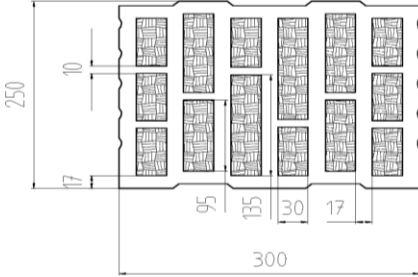
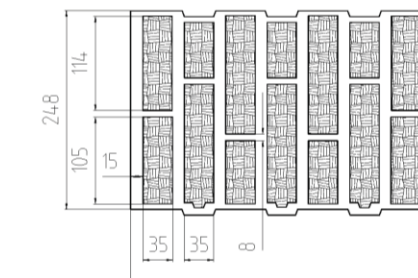
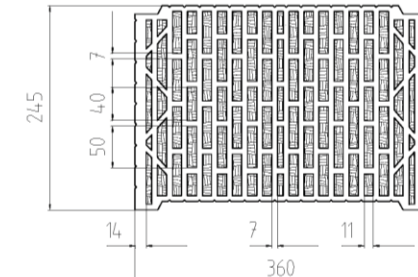
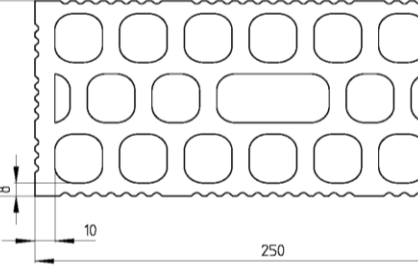
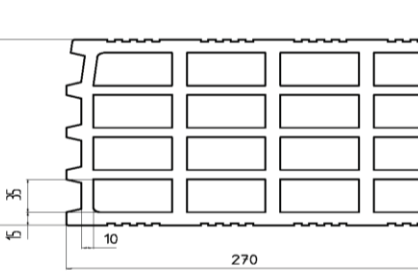
Brick No./ Country	Dimensions	Brick drawing	See Annex
S11/DE	10 DF 300 x 250 x 240 mm		C 11
S12/DE	10 DF 365 x 248 x 240 mm		C 11
S13/DE	10 DF 360 x 245 x 240 mm		C 11
S14/IT	250 x 120 x 190 mm		C 12
S15/FR	500 x 200 x 270 mm		C 12

fischer frame fixing SXR / SXRL

**Intended use**  
Summary of hollow and perforated bricks

**Anhang B 8**

**Table B9.1: Summary of hollow and perforated bricks – see Annex C12 – C14**

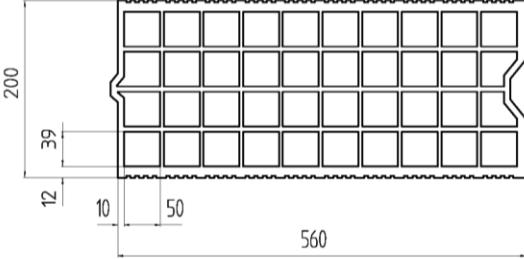
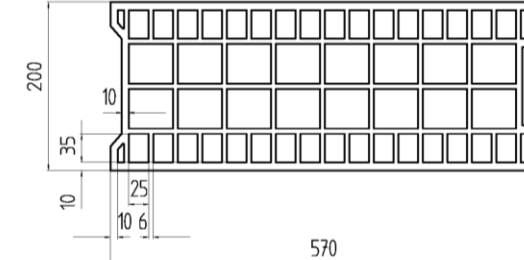
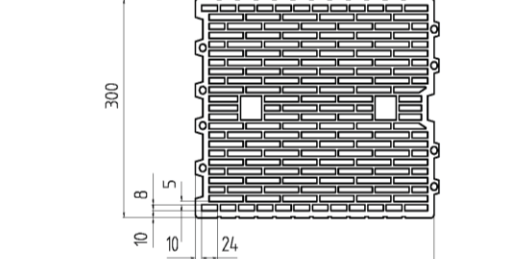
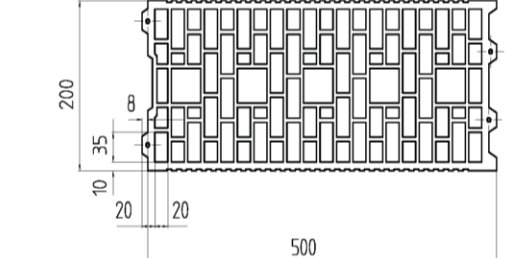
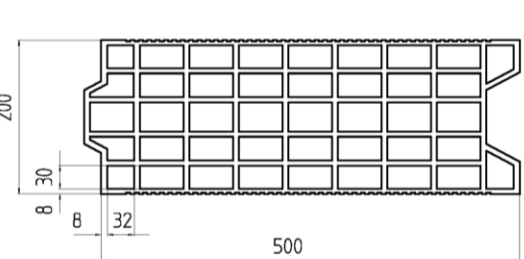
Brick No./ Country	Dimensions	Brick drawing	See Annex
S16/FR	560 x 200 x 275 mm		C 12
S17/FR	570 x 200 x 315 mm		C 13
S18/FR	370 x 300 x 250 mm		C 13
S19/FR	500 x 200 x 275 mm		C 13
S20/FR	500 x 200 x 220 mm		C 14

**fischer frame fixing SXR / SXRL**

**Anhang B 9**

**Intended use**  
Summary of hollow and perforated bricks

**Table B10.1: Summary of hollow and perforated bricks – see Annex C14 – C15**

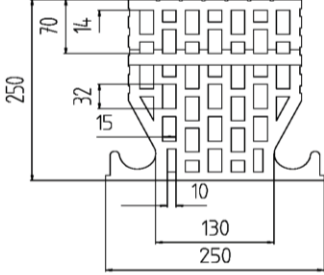
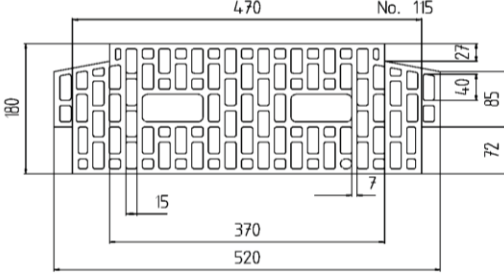
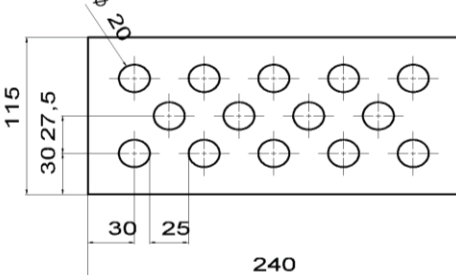
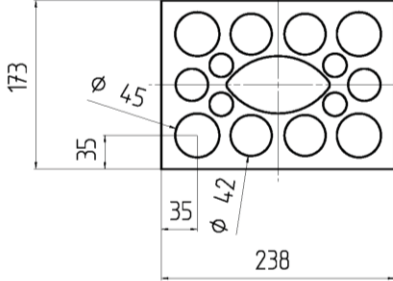
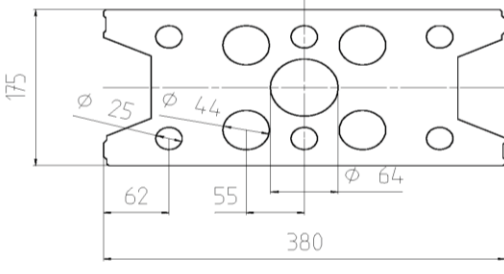
Brick No./ Country	Dimensions	Brick drawing	See Annex
S21/DE	250 x 250 x 190 mm		C 14
S22/DE	520 x 180 x 250 mm		C 14
S23/DE	2 DF 240 x 115 x 113 mm		C 15
S24/DE	3 DF 240 x 175 x 113 mm		C 15
S25/DE	9 DF 380 x 175 x 240 mm		C 15

fischer frame fixing SXR / SXRL

**Intended use**  
Summary of hollow and perforated bricks

**Anhang B 10**

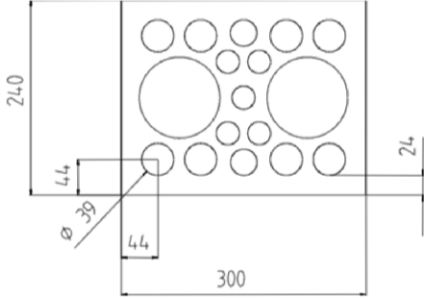
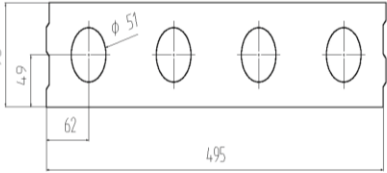
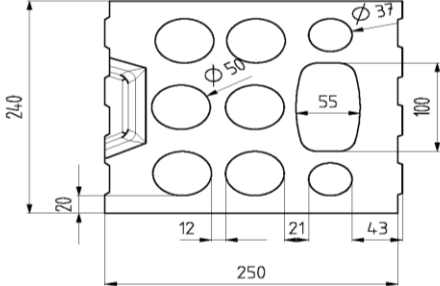
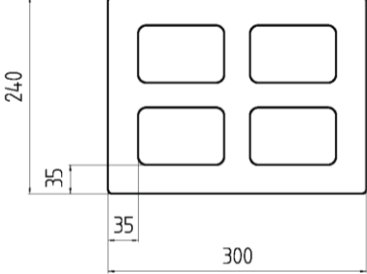
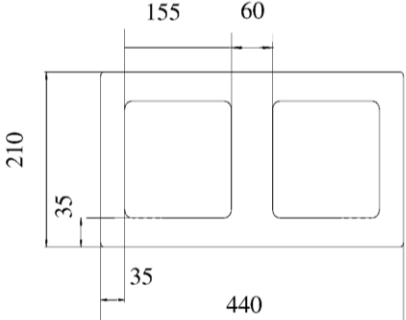

**Table B11.1: Summary of hollow and perforated bricks – see Annex C16 – C17**

Brick No./ Country	Dimensions	Brick drawing	See Annex
S26/DE	5 DF 300 x 240 x 113 mm		C 16
S27/DE	2 DF 495 x 98 x 245 mm		C 16
S28/DE	9 DF 250 x 240 x 240 mm		C 16
S29/DE	300 x 240 x 240 mm		C 17
S30/IE	440 x 210 x 215 mm		C 17

fischer frame fixing SXR / SXRL

**Intended use**  
Summary of hollow and perforated bricks

**Anhang B 11**

**Table B12.1: Summary of hollow and perforated bricks – see Annex C17 – C19**

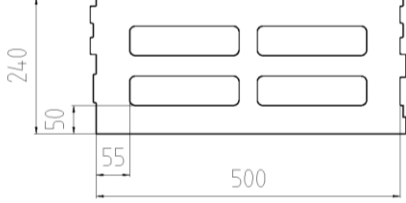
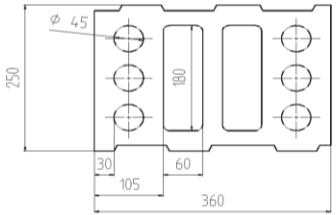
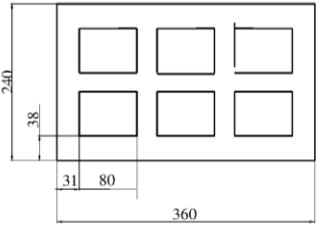
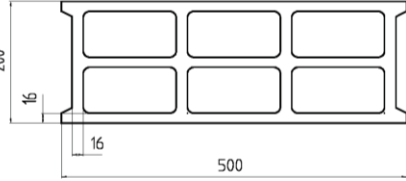
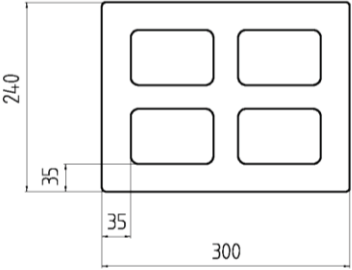
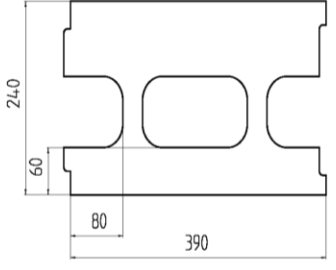
Brick No./ Country	Dimensions	Brick drawing	See Annex
S31/DE	500 x 240 x 240 mm		C 17
S32/DE	360 x 250 x 250 mm		C 18
S33/DE	360 x 240 x 240 mm		C 18
S34/FR	500 x 200 x 200 mm		C 18
S35/DE	300 x 240 x 240 mm		C 19
S36/DE	390 x 240 x 240		C 19

**fischer frame fixing SXR / SXRL**

**Intended use**  
Summary of hollow and perforated bricks

**Anhang B 12**

**Table C1.1: Characteristic resistance of the screw**

Failure of expansion element (special screw)		SXR 8 / SXRL 8		SXR 10 / SXRL 10		SXRL 14	
		galvanised steel	stainless steel (A2 and A4)	galvanised steel	stainless steel (A2 and A4)	galvanised steel	stainless steel (A2 and A4)
Characteristic tension resistance	$N_{Rk,s}$ [kN]	14,8	14,3	21,7 24,9 <sup>2)</sup>	21,7	43,4	42,0
Partial safety factor	$\gamma_{Ms}$ <sup>1)</sup>	1,50	1,55	1,55	1,55	1,50	1,55
Characteristic shear resistance	$V_{Rk,s}$ [kN]	7,4	7,1	10,8 12,4 <sup>2)</sup>	10,8	21,7	21,0
Partial safety factor	$\gamma_{Ms}$ <sup>1)</sup>	1,25	1,29	1,29	1,29	1,25	1,29

<sup>1)</sup> In absence of other national regulations.

<sup>2)</sup> Only for SXRL 10: "High load" screw version on request only for countersunk screws – head marking is ●●

**Table C1.2: Characteristic bending resistance of the screw**

Anchor type		SXR 8 / SXRL 8		SXR 10 / SXRL 10		SXRL 14			
		galvanised steel	stainless steel (A2 and A4)	galvanised steel	stainless steel (A2 and A4)	galvanised steel		stainless steel (A2 and A4)	
Overall plastic anchor embedment depth in the base material						$h_{nom2}$ 70mm	$h_{nom3}$ 90mm	$h_{nom2}$ 70mm	$h_{nom3}$ 90mm
Characteristic bending resistance	$M_{Rk,s}$ [Nm]	12,4	12,0	20,6 23,6 <sup>2)</sup>	20,6	48,7	62,5	47,0	60,5
Partial safety factor	$\gamma_{Ms}$ <sup>1)</sup>	1,25	1,29	1,29	1,29	1,25		1,29	

<sup>1)</sup> In absence of other national regulations.

<sup>2)</sup> Only for SXRL 10: "High load" screw version on request only for countersunk screws – head marking is ●●

**Table C1.3: Characteristic resistance for use in concrete (use cat. "a")**

Pull-out failure (plastic sleeve)			SXR 8	SXRL 8	SXR 10	SXRL 10	SXRL 14
Embedment depth $h_{nom}$ [mm]			50	50 70	50	50 70	70
<b>Concrete <math>\geq</math> C12/15</b>							
Characteristic resistance 30/50 °C	$N_{Rk,p}$ [kN]		3,0	4,0 5,0	5,0	5,5 6,5	8,5
Characteristic resistance 50/80 °C	$N_{Rk,p}$ [kN]		2,5 3,0 <sup>2)</sup>	4,0 5,0	4,5	5,0 6,5	8,5
<b>Concrete <math>\geq</math> C12/15 (e.g. weather resistant shells of external wall panels)</b>							
Characteristic resistance 30/50 °C	$N_{Rk,p}$ [kN]	$h \geq 40$ mm	-	- -	3,5	2,5 3,0 <sup>2)</sup>	- -
Characteristic resistance 50/80 °C	$N_{Rk,p}$ [kN]	$h \geq 40$ mm	-	- -	3,0	2,5 3,0 <sup>2)</sup>	- -
<b>Concrete <math>\geq</math> C45/55 in pre-stressed concrete core slabs</b>							
Characteristic resistance 50/80 °C	$N_{Rk,p}$ [kN]	$d_b \geq 30$ mm	-	- -		3,5 4,0 <sup>3)</sup>	- -
		$d_b \geq 40$ mm	-	- -		5,5 6,0 <sup>3)</sup>	- -
Partial safety factor		$\gamma_{Mc}$ <sup>1)</sup>	1,8				

<sup>1)</sup> In absence of other national regulations.

<sup>2)</sup> Value corresponds to concrete class  $\geq$  C16/20.

<sup>3)</sup> only valid for temperature range 30 / 50 °C

fischer frame fixing SXR / SXRL

**Performances**

Characteristic resistance and characteristic bending resistance of the screw  
Characteristic resistance for use in concrete

**Annex C 1**

**Table C2.1: Displacements<sup>1)</sup> under tension and shear loading in concrete and masonry**

Anchor type	h <sub>nom</sub> [mm]	F [kN]	Tension load <sup>2)</sup>		Shear load <sup>2)</sup>	
			δ <sub>NO</sub> [mm]	δ <sub>N∞</sub> [mm]	δ <sub>VO</sub> [mm]	δ <sub>V∞</sub> [mm]
SXR 8	50	1,2	0,65	1,30	1,02	1,53
SXRL 8	50	1,6	0,56	1,12	2,00	3,00
	70	2,0	0,64	1,28	2,30	3,45
SXR 10	50	2,0	1,29	2,58	1,15 <sup>3)</sup> /3,05 <sup>4)</sup>	1,74 <sup>3)</sup> /4,58 <sup>4)</sup>
SXRL 10	50	2,2	0,58	1,16	1,96	2,94
	70	2,6	1,67	3,34	1,15 <sup>3)</sup> /3,05 <sup>4)</sup>	1,74 <sup>3)</sup> /4,58 <sup>4)</sup>
SXRL 14	70	3,40	0,39	0,63	2,79	4,19

1) Valid for all ranges of temperatures.

2) Intermediate values by linear interpolation.

3) Valid for diameter in the clearance hole ≤ 10,5 mm (see Table B2.1).

4) Valid for diameter in the clearance hole = 12,5 mm (see Table B2.1).

**Table C2.2: Displacements<sup>1)</sup> under tension and shear loading in autoclaved aerated concrete AAC**

Anchor type	f <sub>b</sub> [N/mm <sup>2</sup> ]	h <sub>nom</sub> [mm]	F [kN]	Tension load <sup>2)</sup>		Shear load <sup>2)</sup>	
				δ <sub>NO</sub> [mm]	δ <sub>N∞</sub> [mm]	δ <sub>VO</sub> [mm]	δ <sub>V∞</sub> [mm]
SXRL 8	≥ 2	70/90	0,14/0,21	0,45/0,55	0,90/1,10	0,28/0,42	0,42/0,63
	≥ 6	70/90	1,07	0,73/0,80	1,46/1,60	2,14	3,21
SXR 10	≥ 2	50	0,32	0,03	0,06	0,21	0,31
SXRL 10	≥ 2	70/90	0,32	0,23	0,46	0,64	0,96
	≥ 6	70/90	1,43	0,65	1,30	2,86	4,29
SXRL 14	≥ 2	70/90	0,32/0,43	0,19/0,25	0,38/0,50	0,64/0,86	0,96/1,29
	≥ 3	70/90	0,60/0,77	0,23/0,31	0,45/0,63	1,19/1,54	1,79/2,31
	≥ 4	70/90	0,88/1,11	0,26/0,38	0,53/0,76	1,75/2,22	2,62/3,33
	≥ 6	70/90	1,43/1,79	0,34/0,51	0,68/1,02	2,86/3,58	4,29/5,37

1) Valid for all ranges of temperatures.

2) Intermediate values by linear interpolation.

**Table C2.3: Values under fire exposure in concrete C20/25 to C50/60 in any load direction, no permanent centric tension load and without lever arm**

Anchor type	Fire resistance class	F <sub>Rk,fi,90</sub>	γ <sub>M,fi</sub> <sup>1)</sup>
SXR 10 / SXRL 10 / SXRL 14	R 90	≤ 0,8 kN	1,0

1) In absence of other national regulations.

If one-side fire load, see table B3.1 for edge distance

In case of fire attack from more than one side the minimum edge distance shall be c ≥ 300 mm, c ≥ 2 • h<sub>ef</sub>; the bigger value is decisive

fischer frame fixing SXR / SXRL

**Performances**

Displacements under tension and shear loading in concrete, masonry and aerated concrete

**Annex C 2**

**Table C3.1: Characteristic resistance  $F_{Rk}$  in [kN] in solid masonry (use category “b”)**

Base material [Supplier Title] Geometry, DF or nom. size (L x W x H) [mm] and drilling method	Min. compressive strength $f_b$ [N/mm <sup>2</sup> ] / bulk density $\rho$ [kg/dm <sup>3</sup> ]	Characteristic resistance $F_{Rk}$ [kN] 50/80°C									
		SXR 8	SXRL 8			SXR 10	SXRL 10		SXRL 14		
		h <sub>nom</sub> [mm]									
		≥ 50	≥ 50	≥ 70	≥ 90	≥ 50	≥ 50	≥ 70	≥ 70	≥ 90	
<b>Clay brick Mz</b> , acc. to EN 771-1:2011 <i>e.g. Schlagmann DE</i> <b>3 DF</b> (240x175x113) hammer drilling	20/1,8	<b>3,0</b>	-	-	-	<b>2,0</b> <b>4,0<sup>4)</sup></b> <b>4,5<sup>6)</sup></b>	-	-	-	-	
	10/1,8	<b>2,0</b>	-	-	-	<b>3,0<sup>4)</sup></b>	-	-	-	-	
<b>Clay brick Mz</b> , acc. to EN 771-1:2011 <i>e.g. Schlagmann DE</i> <i>e.g. Ebersdobler DE</i> <b>NF</b> (240x115x71) hammer drilling	36/1,8	<b>2,5</b>	<b>3,0</b>	<b>4,0</b> <b>4,5<sup>3)</sup></b>	<sup>8)</sup>	<b>5,0</b>	<b>3,5</b>	<b>4,0</b> <b>5,5<sup>3)</sup></b>	<b>4,0</b> <b>6,0<sup>4)</sup></b> <b>7,0<sup>6)</sup></b>	<sup>8)</sup>	
	20/1,8	<b>2,5</b>	<b>3,0</b>	<b>4,0</b> <b>4,5<sup>3)</sup></b>	<sup>8)</sup>	<b>3,0</b> <b>3,5<sup>2)</sup></b>	<b>3,5</b>	<b>4,0</b> <b>5,5<sup>3)</sup></b>	<b>4,0</b> <b>6,0<sup>4)</sup></b> <b>7,0<sup>6)</sup></b>	<sup>8)</sup>	
	12/1,8	<b>2,0</b>	<b>2,0</b>	<b>2,5</b>	<sup>8)</sup>	<b>2,0</b>	<b>2,0</b>	<b>4,0</b> <b>5,5<sup>3)</sup></b>	<b>3,0</b> <b>4,5<sup>4)</sup></b> <b>5,0<sup>6)</sup></b>	<sup>8)</sup>	
	10/1,8	<b>2,0</b>	<b>2,0</b>	<b>2,5</b>	<sup>8)</sup>	<b>2,0</b>	-	<b>3,5</b> <b>4,5<sup>3)</sup></b>	<b>3,0</b> <b>4,5<sup>4)</sup></b> <b>5,0<sup>6)</sup></b>	<sup>8)</sup>	
<b>Clay brick Mz</b> , acc. to EN 771-1:2011 <i>e.g. Wienerberger, DK</i> <b>DF</b> (240x115x52) hammer drilling	28/1,8	<b>3,0</b>	<b>2,5</b>	<b>3,0</b> <b>3,5<sup>2)</sup></b>	<sup>8)</sup>	<b>3,0</b>	<b>3,0</b> <b>4,5<sup>3)</sup></b> <b>5,0<sup>5)</sup></b>	<b>5,5</b> <b>6,5<sup>3)</sup></b>	-	-	
	20/1,8	<b>2,0</b>	<b>2,5</b>	<b>3,0</b> <b>3,5<sup>2)</sup></b>	<sup>8)</sup>	<b>2,0</b>	<b>3,0</b> <b>4,5<sup>3)</sup></b> <b>5,0<sup>5)</sup></b>	<b>4,0</b> <b>4,5<sup>3)</sup></b>	-	-	
	16/1,8	<b>1,5</b>	<b>2,5</b>	<b>3,0</b> <b>3,5<sup>2)</sup></b>	<sup>8)</sup>	<b>1,5</b>	<b>3,0</b> <b>4,5<sup>3)</sup></b> <b>5,0<sup>5)</sup></b>	<b>3,0</b> <b>3,5<sup>3)</sup></b>	-	-	
	12/1,8	<b>1,5</b>	<b>1,5</b> <b>2,0<sup>2)</sup></b>	<b>2,0</b> <b>2,5<sup>2)</sup></b>	<sup>8)</sup>	<b>1,2</b>	<b>2,5</b> <b>3,5<sup>3)</sup></b>	<b>2,5</b> <b>3,0<sup>3)</sup></b>	-	-	
	10/1,8	<b>1,5</b>	<b>1,2</b> <b>1,5<sup>2)</sup></b>	<sup>8)</sup>	<sup>8)</sup>	<b>1,2</b>	-	<b>2,5</b> <b>3,0<sup>3)</sup></b>	-	-	
Partial safety factor	$\gamma_{Mm}$ <sup>1)</sup>	<b>2,5</b>									

1) In absence of other national regulations.

2) Only valid for temperature range 30/50° C.

3) Only valid for edge distance  $c \geq 150$  mm; intermediate values by linear interpolation.

4) Only valid for edge distance  $c \geq 200$  mm; intermediate values by linear interpolation.

5) Only valid for edge distance  $c \geq 150$  mm for temperature range 30/50° C; intermediate values by linear interpolation.

6) Only valid for edge distance  $c \geq 200$  mm for temperature range 30/50° C; intermediate values by linear interpolation.

8) Values of lower  $h_{nom}$  can also be taken for next higher  $h_{nom}$ .

fischer frame fixing SXR / SXRL

Performances

Characteristic resistance for use in solid masonry

Annex C 3

**Table C4.1: Characteristic resistance  $F_{Rk}$  in [kN] in solid masonry (use category “b”)**

Base material [Supplier Title] Geometry, DF or nom. size (L x W x H) [mm] and drilling method	Min. compressive strength $f_b$ [N/mm <sup>2</sup> ] / bulk density $\rho$ [kg/dm <sup>3</sup> ]	Characteristic resistance $F_{Rk}$ [kN] 50/80°C									
		SXR 8	SXRL 8		SXR 10	SXRL 10		SXRL 14			
		$h_{nom}$ [mm]									
		≥ 50	≥ 50	≥ 70	≥ 90	≥ 50	≥ 50	≥ 70	≥ 70	≥ 90	
<b>Calcium silicate solid brick KS</b> , acc. to EN 771-2:2011 e.g. <i>KS Wemding DE NF</i> (240x115x71) hammer drilling	36/2,0	-	-	-	-	5,0	3,5 4,0 <sup>3)</sup>	8)	-	-	
	20/2,0	-	-	-	-	3,0 3,5 <sup>2)</sup>	3,5 4,0 <sup>3)</sup>	8)	-	-	
	20/1,8	2,5	2,5	3,0	8)	2,5 4,0 <sup>4)</sup>	-	3,5	4,5 5,0 <sup>4)</sup> 6,0 <sup>6)</sup>	8)	
	10/2,0	-	-	-	-	2,0	2,0 2,5 <sup>3)</sup>	8)	-	-	
	10/1,8	2,0	2,0	2,0	8)	1,5	-	2,5	3,0 3,5 <sup>4)</sup> 4,0 <sup>6)</sup>	8)	
<b>Calcium silicate solid brick KS</b> , acc. to EN 771-2:2011 e.g. <i>KS Wemding 12 DF</i> (495x175x240) hammer drilling	28/2,0	3,0	-	-	-	5,0	-	-	-	-	
	20/2,0	3,0	-	-	-	4,5	-	-	-	-	
	20/1,8	-	-	-	-	-	-	6,5 8,5 <sup>4)</sup>	4,0 11,0 <sup>4)</sup> 11,5 <sup>6)</sup>	8)	
	16/1,8	-	-	-	-	-	-	6,5 8,5 <sup>4)</sup>	4,0 11,0 <sup>4)</sup> 11,5 <sup>6)</sup>	8)	
	12/1,8	-	-	-	-	-	-	6,5 8,5 <sup>4)</sup>	4,0 11,0 <sup>4)</sup> 11,5 <sup>6)</sup>	8)	
	10/2,0	2,5	-	-	-	3,0	-	-	-	-	
	10/1,8	-	-	-	-	-	-	5,5 7,0 <sup>4)</sup>	3,5 9,0 <sup>4)</sup> 9,5 <sup>6)</sup>	8)	
	8/1,8	-	-	-	-	-	-	4,0 5,5 <sup>4)</sup>	2,5 7,5 <sup>4)</sup>	8)	
Partial safety factor	$\gamma_{Mm}$ <sup>1)</sup>	2,5									

1) In absence of other national regulations.

2) Only valid for temperature range 30/50° C.

3) Only valid for edge distance  $c \geq 150$  mm; intermediate values by linear interpolation.

4) Only valid for edge distance  $c \geq 200$  mm; intermediate values by linear interpolation.

5) Only valid for edge distance  $c \geq 150$  mm for temperature range 30/50° C; intermediate values by linear interpolation.

6) Only valid for edge distance  $c \geq 200$  mm for temperature range 30/50° C; intermediate values by linear interpolation.

8) Values of lower  $h_{nom}$  can also be taken for next higher  $h_{nom}$ .

fischer frame fixing SXR / SXRL

Performances

Characteristic resistance for use in solid masonry

Annex C 4

**Table C5.1: Characteristic resistance  $F_{Rk}$  in [kN] in solid masonry (use category "b")**

Base material [Supplier Title] Geometry, DF or nom. size (L x W x H) [mm] and drilling method	Min. compressive strength $f_b$ [N/mm <sup>2</sup> ] / bulk density $\rho$ [kg/dm <sup>3</sup> ]	Characteristic resistance $F_{Rk}$ [kN] 50/80°C								
		SXR 8	SXRL 8			SXR 10	SXRL 10		SXRL 14	
		h <sub>nom</sub> [mm]								
		≥ 50	≥ 50	≥ 70	≥ 90	≥ 50	≥ 50	≥ 70	≥ 70	≥ 90
<b>Calcium silicate solid brick KS</b> , acc. to EN 771-2:2011 e.g. <i>KS Wemding DE</i> <b>8 DF</b> (495x115x240) hammer drilling	16/2,0	-	3,0 4,5 <sup>3)</sup> 5,0 <sup>6)</sup>	3,5 5,0 <sup>3)</sup> 6,0 <sup>4)</sup> 6,5 <sup>6)</sup>	8)	-	3,5 5,0 <sup>3)</sup> 6,0 <sup>4)</sup> 6,5 <sup>6)</sup>	8)	-	-
	12/2,0	-	2,5 3,0 <sup>3)</sup> 3,5 <sup>5)</sup>	2,5 4,0 <sup>3)</sup> 4,5 <sup>4)</sup> 5,0 <sup>6)</sup>	8)	-	2,5 4,0 <sup>3)</sup> 4,5 <sup>4)</sup> 5,0 <sup>6)</sup>	8)	-	-
<b>Lightweight solid brick Vbl</b> , acc. to EN 771-3:2011 e.g. <i>KLB DE</i> <b>2 DF</b> (240x115x113) hammer drilling	4/1,4	-	-	-	-	0,75	-	2,5	-	-
	2/1,4	-	-	-	-	0,4	-	1,2	-	-
	2/1,2	0,9	0,4 0,5 <sup>2)</sup>	0,9 1,2 <sup>2)</sup>	8)	0,75 0,9 <sup>3)</sup>	0,4	8)	0,9 1,2 <sup>2)</sup>	8)
<b>Lightweight solid brick Vbl</b> , acc. to EN 771-3:2011 e.g. <i>KLB DE</i> <b>8 DF</b> (490x240x115) hammer drilling	12/1,8	2,5	-	-	-	-	-	3,0 4,5 <sup>3)</sup>	-	-
	10/1,8	2,5	-	-	-	-	-	2,5 3,5 <sup>3)</sup>	-	-
	8/1,8	2,5	-	-	-	-	-	2,0 3,0 <sup>3)</sup>	-	-
	8/1,6	-	-	-	-	3,0	-	-	-	-
	6/1,8	2,0	-	-	-	-	-	1,5 2,0 <sup>3)</sup>	-	-
	6/1,6	-	-	-	-	2,0	-	-	-	-
	4/1,8	1,2	-	-	-	-	-	0,9 1,5 <sup>3)</sup>	-	-
	2/1,2	-	-	-	-	1,2	-	-	-	-
2/1,0	1,2	-	-	-	-	-	-	-	-	
Partial safety factor	$\gamma_{Mm}$ <sup>1)</sup>	2,5								

1) In absence of other national regulations.

2) Only valid for temperature range 30/50° C.

3) Only valid for edge distance  $c \geq 150$  mm; intermediate values by linear interpolation.

4) Only valid for edge distance  $c \geq 200$  mm; intermediate values by linear interpolation.

5) Only valid for edge distance  $c \geq 150$  mm for temperature range 30/50° C; intermediate values by linear interpolation.

6) Only valid for edge distance  $c \geq 200$  mm for temperature range 30/50° C; intermediate values by linear interpolation.

8) Values of lower  $h_{nom}$  can also be taken for next higher  $h_{nom}$ .

fischer frame fixing SXR / SXRL

Performances

Characteristic resistance for use in solid masonry

Annex C 5

**Table C6.1: Characteristic resistance  $F_{Rk}$  in [kN] in solid masonry (use category “b”)**

Base material [Supplier Title] Geometry, DF or nom. size (L x W x H) [mm] and drilling method	Min. com- pressive strength $f_b$ [N/mm <sup>2</sup> ] / bulk density $\rho$ [kg/dm <sup>3</sup> ]	Characteristic resistance $F_{Rk}$ [kN] 50/80°C								
		SXR 8	SXRL 8			SXR 10	SXRL 10		SXRL 14	
		h <sub>nom</sub> [mm]								
		≥ 50	≥ 50	≥ 70	≥ 90	≥ 50	≥ 50	≥ 70	≥ 70	≥ 90
<b>Lightweight solid brick Vbl</b> , acc. to EN 771-3:2011 e.g. <i>KLB DE</i> <b>8 DF</b> (245x240x240) hammer drilling	10/1,6	-	2,0 2,5 <sup>2)</sup>	3,0 4,0 <sup>5)</sup>	8)	2,5	3,0 3,5 <sup>5)</sup>	7,5	3,5 6,0 <sup>4)</sup> 7,0 <sup>6)</sup>	8)
	8/1,6	-	1,5 2,0 <sup>2)</sup>	2,5 3,5 <sup>5)</sup>	8)	2,5	2,5 3,0 <sup>5)</sup>	6,0	3,0 5,0 <sup>4)</sup> 6,0 <sup>6)</sup>	8)
	6/1,6	-	1,2 1,5 <sup>2)</sup>	2,0 2,5 <sup>5)</sup>	8)	2,5	2,0	4,5	2,0 3,5 <sup>4)</sup> 4,5 <sup>6)</sup>	8)
	6/1,4	0,9	-	-	-	-	-	-	-	-
	4/1,6	-	0,75 0,9 <sup>2)</sup>	1,2 1,5 <sup>5)</sup>	8)	0,9	1,2 1,5 <sup>5)</sup>	3,0	1,5 2,5 <sup>4)</sup> 3,0 <sup>6)</sup>	8)
	4/1,4	0,6 0,75 <sup>2)</sup>	-	-	-	-	-	-	-	-
	2/1,6	-	0,4 0,5 <sup>2)</sup>	0,6 0,9 <sup>5)</sup>	8)	0,5	0,6	1,5	-	-
<b>Lightweight solid brick Vbl</b> , acc. to EN 771-3:2011, e.g. <i>Liapor Super-K DE</i> <b>16 DF</b> (500x240x248) hammer drilling	2/0,8	-	-	-	-	-	-	0,5	-	-
<b>Lightweight solid brick Vbl</b> , acc. to EN 771-3:2011, e.g. <i>Tarmac UK</i> (440x100x215) hammer drilling	6/1,4	-	-	-	-	2,0 2,5 <sup>4)</sup>	-	2,0 3,0 <sup>3)</sup>	-	-
	4/1,4	-	-	-	-	1,2 1,5 <sup>4)</sup>	-	1,2 2,0 <sup>3)</sup>	-	-
Partial safety factor	$\gamma_{Mm}$ <sup>1)</sup>	2,5								

1) In absence of other national regulations.

2) Only valid for temperature range 30/50° C.

3) Only valid for edge distance  $c \geq 150$  mm; intermediate values by linear interpolation.

4) Only valid for edge distance  $c \geq 200$  mm; intermediate values by linear interpolation.

5) Only valid for edge distance  $c \geq 150$  mm for temperature range 30/50° C; intermediate values by linear interpolation.

6) Only valid for edge distance  $c \geq 200$  mm for temperature range 30/50° C; intermediate values by linear interpolation.

8) Values of lower  $h_{nom}$  can also be taken for next higher  $h_{nom}$ .

fischer frame fixing SXR / SXRL

Performances

Characteristic resistance for use in solid masonry

Annex C 6



**Table C7.1: Characteristic resistance  $F_{Rk}$  in [kN] in solid masonry (use category “b”)**

Base material [Supplier Title] Geometry, DF or nom. size (L x W x H) [mm] and drilling method	Min. compressive strength $f_b$ [N/mm <sup>2</sup> ] / bulk density $\rho$ [kg/dm <sup>3</sup> ]	Characteristic resistance $F_{Rk}$ [kN] 50/80°C									
		SXR 8	SXRL 8			SXR 10	SXRL 10		SXRL 14		
		h <sub>nom</sub> [mm]									
		≥ 50	≥ 50	≥ 70	≥ 90	≥ 50	≥ 50	≥ 70	≥ 70	≥ 90	
<b>Solid brick normal concrete Vbn</b> , acc. to EN 771-3:2011 e.g. <i>Adolf Blatt DE</i> (240x245x240) hammer drilling	20/1,8	2,5	-	-	-	4,5	-	-	-	-	
	16/1,8	2,5	-	-	-	3,5	-	-	-	-	
	12/1,8	2,5	-	-	-	3,0	-	-	-	-	
	10/1,8	1,5	-	-	-	3,0	-	-	-	-	
	8/1,8	1,5	-	-	-	-	-	-	-	-	
	4/1,8	0,75	-	-	-	-	-	-	-	-	
<b>Solid brick normal concrete Vbn</b> , acc. to EN 771-3:2011 e.g. <i>Tarmac UK</i> (440x100x215) hammer drilling	16/1,8	-	-	-	-	4,0 4,5 <sup>2)</sup>	-	5,5	-	-	
	10/1,8	-	-	-	-	2,5 3,0 <sup>2)</sup>	-	3,5	-	-	
Partial safety factor	$\gamma_{Mm}$ <sup>1)</sup>	2,5									

Footnotes see C7.2

**Table C7.2: Characteristic resistance  $F_{Rk}$  in [kN] in hollow or perforated masonry (use category “c”)**

Base material [Supplier Title] Geometry, DF or nom. size (L x W x H) [mm] and drilling method	Min. compressive strength $f_b$ [N/mm <sup>2</sup> ] / bulk density $\rho$ [kg/dm <sup>3</sup> ]	Characteristic resistance $F_{Rk}$ [kN] 50/80°C									
		SXR 8	SXRL 8			SXR 10	SXRL 10		SXRL 14		
		h <sub>nom</sub> [mm]									
		50	50	70	90	50	50	70	70	90	
<b>S1 Perforated clay brick</b> <b>HLz Form B</b> , acc. to EN 771-1:2011 e.g. <i>Wienerberger</i>	20/1,2	1,2	-	-	-	2,5 3,0 <sup>5)</sup>	-	2,0	-	-	
	20/1,0	-	-	-	-	2,0	-	-	-	-	
	12/1,2	-	-	-	-	-	-	1,2	-	-	
	10/1,2	-	-	-	-	1,5 2,0 <sup>2)</sup>	-	-	-	-	
	10/1,0	-	-	-	-	1,2	-	-	-	-	
	8/1,2	0,5	-	-	-	-	-	-	-	-	
<b>2 DF (240x115x113)</b> rotary drilling	8/1,2	0,5	-	-	-	-	-	-	-	-	
	Partial safety factor	$\gamma_{Mm}$ <sup>1)</sup>	2,5								

1) In absence of other national regulations.

2) Only valid for temperature range 30/50° C.

5) Only valid for edge distance  $c \geq 150$  mm at temperature range 30/50° C; intermediate values by linear interpolation.



fischer frame fixing SXR / SXRL

**Performances**

Characteristic resistance for use in solid masonry and in hollow or perforated masonry

**Annex C 7**

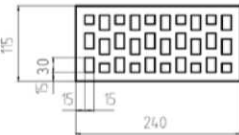
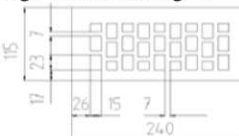
**Table C8.1: Characteristic resistance  $F_{Rk}$  in [kN] in hollow or perforated masonry (use category “c”)**

Base material [Supplier Title] Geometry, DF or nom. size (L x W x H) [mm] and drilling method	Min. compressive strength $f_b$ [N/mm <sup>2</sup> ] / bulk density $\rho$ [kg/dm <sup>3</sup> ]	Characteristic resistance $F_{Rk}$ [kN] 50/80°C								
		SXR 8	SXRL 8 <sup>7)</sup>			SXR 10	SXRL 10		SXRL 14 <sup>7)</sup>	
		$h_{nom}$ [mm]								
		50	50	70	90	50	50	70	70	90
<b>S2 Perforated clay brick HLz</b> acc. to EN 771-1:2011 e.g. Wienerberger  <b>2 DF (240x115x113)</b> rotary drilling	28/1,2		1,2 1,5 <sup>2)</sup>	1,5 2,0 <sup>2)</sup>	1,5 2,0 <sup>2)</sup>	-	-	2,0	-	-
	20/1,2		0,9 1,2 <sup>2)</sup>	0,9 1,2 <sup>2)</sup>	1,2 1,5 <sup>2)</sup>	-	-	1,2	-	-
	12/1,0	0,6	-	-	-	0,9	-	0,75	-	-
	10/1,2	-	0,6	0,6 0,75 <sup>2)</sup>	0,6 0,9 <sup>2)</sup>	-	-	-	-	-
	10/1,0	-	-	-	-	0,75	-	0,6	-	-
	8/1,0	0,4	-	-	-	0,6	-	-	-	-
<b>S3 Perforated clay brick VHLz</b> acc. to EN 771-1:2011, e.g. Wienerberger  <b>NF (240x115x71)</b> rotary drilling	48/1,6	-	-	-	-	-	-	4,5 5,0 <sup>2)</sup>	4,5 5,0 <sup>2)</sup>	
	28/1,6	-	-	-	-	-	-	2,5 3,0 <sup>2)</sup>	2,5 3,0 <sup>2)</sup>	
	20/1,6	-	-	-	-	-	-	1,5 2,0 <sup>2)</sup>	1,5 2,0 <sup>2)</sup>	
<b>S4 Perforated clay brick VHLz</b> acc. to EN 771-1:2011, e.g. Wienerberger  <b>2 DF (240x115x113)</b> rotary drilling	48/1,6	-	2,5	2,5	1,5 2,0 <sup>2)</sup>	2,5	-	4,5	-	-
	36/1,6	-	2,0	2,0	1,2 1,5 <sup>2)</sup>	2,0	-	3,0	-	-
	28/1,6	-	1,5	1,5	0,9 1,2 <sup>2)</sup>	1,5	-	2,5	-	-
	20/1,6	-	0,9	0,9	0,6 0,9 <sup>2)</sup>	0,9	-	1,5	-	-
	12/1,6	-	0,6	0,6	0,4 0,5 <sup>2)</sup>	0,6	-	0,9	-	-
	10/1,6	-	-	-	-	-	-	0,9	-	-
Partial safety factor	$\gamma_{Mm}$ <sup>1)</sup>	2,5								

1) In absence of other national regulations.  
 2) Only valid for temperature range 30/50° C.  
 3) Only valid for edge distance  $c \geq 150$  mm; intermediate values by linear interpolation.  
 4) Only valid for edge distance  $c \geq 200$  mm; intermediate values by linear interpolation.  
 5) Only valid for edge distance  $c \geq 150$  mm at temperature range 30/50° C; intermediate values by linear interpolation.  
 6) Only valid for edge distance  $c \geq 200$  mm at temperature range 30/50° C; intermediate values by linear interpolation.  
 7) The lowest load of two consecutive embedment depths may be used for the intermediate embedment depths.

fischer frame fixing SXR / SXRL

**Performances**  
 Characteristic resistance for use in hollow or perforated masonry

**Annex C 8**

**Table C9.1: Characteristic resistance  $F_{Rk}$  in [kN] in hollow or perforated masonry (use category "c")**

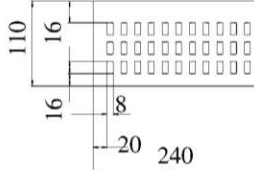
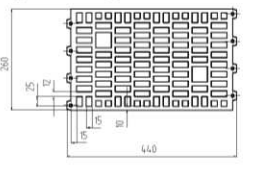
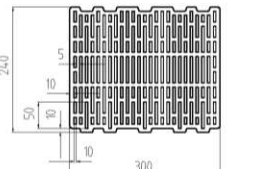
Base material [Supplier Title] Geometry, DF or nom. size (L x W x H) [mm] and drilling method	Min. compressive strength $f_b$ [N/mm <sup>2</sup> ] / bulk density $\rho$ [kg/dm <sup>3</sup> ]	Characteristic resistance $F_{Rk}$ [kN] 50/80°C								
		SXR 8	SXRL 8		SXR 10	SXRL 10		SXRL 14		
		h <sub>nom</sub> [mm]								
		50	50	70	90	50	50	70	70	90
<b>S5 Perforated clay brick</b> <b>HLz acc. to EN 771-1:2011+A1:2014,</b> <i>e.g. Wienerberger, BS</i> 	28/1,5	<b>2,5</b>	-	-	-	<b>2,5</b>	-	-	-	-
	20/1,5	<b>1,2</b> <b>1,5<sup>2)</sup></b>	-	-	-	<b>2,0</b>	-	-	-	-
	10/1,5	<b>0,6</b> <b>0,9<sup>2)</sup></b>	-	-	-	<b>1,2</b>	-	-	-	-
<b>S6 Perforated clay brick</b> <b>HLz Form B, acc. to EN 771-1:2011</b> <i>e.g. Schlagmann</i> 	8/0,9	<b>0,9</b>	-	-	-	-	-	-	-	-
	6/0,9	<b>0,6</b>	-	-	-	-	-	-	-	-
	4/0,9	<b>0,4</b>	-	-	-	-	-	-	-	-
<b>S7 Perforated clay brick</b> <b>HLz acc. to EN 771-1:2011</b> <i>e.g. Schlagmann Poroton T14</i> 	6/0,7	-	-	-	-	<b>0,3</b> <b>0,4<sup>2)</sup></b>	-	<b>0,5</b>	-	-
<b>10 DF (300x240x240)</b> rotary drilling										
Partial safety factor	$\gamma_{Mm}$ <sup>1)</sup>	<b>2,5</b>								

<sup>1)</sup> In absence of other national regulations.

<sup>2)</sup> Only valid for temperature range 30/50° C.



fischer frame fixing SXR / SXRL

**Performances**

Characteristic resistance for use in hollow or perforated masonry

**Annex C 9**

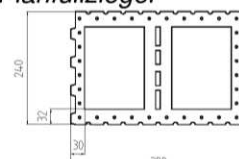
**Table C10.1: Characteristic resistance  $F_{Rk}$  in [kN] in hollow or perforated masonry (use category “c”)**

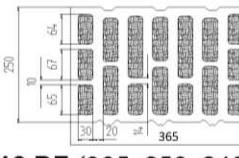
Base material [Supplier Title] Geometry, DF or nom. size (L x W x H) [mm] and drilling method	Min. compressive strength $f_b$ [N/mm <sup>2</sup> ] / bulk density $\rho$ [kg/dm <sup>3</sup> ]	Characteristic resistance $F_{Rk}$ [kN] 50/80°C								
		SXR 8	SXRL 8		SXR 10	SXRL 10		SXRL 14		
		$h_{nom}$ [mm]								
		50	50	70	90	50	50	70	70	90
<b>S8 Perforated clay brick</b> HLz Form B, acc. to EN 771-1:2011, e.g. <i>Schlagmann</i> <i>Planfüllziegel</i>  12 DF (380x240x240) rotary drilling	6/0,7	1,2	-	-	-	2,0	-	-	-	-
	4/0,7	0,75	-	-	-	-	-	-	-	-
	2/0,7	0,4	-	-	-	-	-	-	-	-
<b>S9 Perforated clay brick</b> HLz acc. to EN 771-1:2011 e.g. <i>Schlagmann</i>  3 DF (240x175x113) rotary drilling	12/1,0	-	-	-	-	-	-	-	2,0	2,5
	10/1,0	-	-	-	-	-	-	-	2,0	2,0
	8/1,0	-	-	-	-	-	-	-	1,5	1,5
	6/1,0	-	-	-	-	-	-	-	1,2	1,2
<b>S10 Perforated clay brick</b> HLz acc. to EN 771-1:2011, e.g. <i>Schlagmann</i> <i>Poroton S11</i>  12 DF (365x250x240) rotary drilling	8/0,8	-	-	-	-	-	-	1,5	-	-
	6/0,8	-	-	-	-	-	-	1,2	-	-
	4/0,8	-	-	-	-	-	-	0,75	-	-
Partial safety factor	$\gamma_{Mm}$ <sup>1)</sup>	2,5								

<sup>1)</sup> In absence of other national regulations.

fischer frame fixing SXR / SXRL

**Performances**  
 Characteristic resistance for use in hollow or perforated masonry

**Annex C 10**

**Table C11.1: Characteristic resistance  $F_{Rk}$  in [kN] in hollow or perforated masonry (use category "c")**

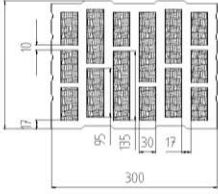
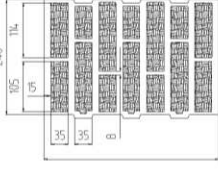
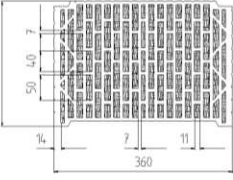
Base material [Supplier Title] Geometry, DF or nom. size (L x W x H) [mm] and drilling method	Min. compressive strength $f_b$ [N/mm <sup>2</sup> ] / bulk density $\rho$ [kg/dm <sup>3</sup> ]	Characteristic resistance $F_{Rk}$ [kN] 50/80°C								
		SXR 8	SXRL 8		SXR 10	SXRL 10		SXRL 14		
		$h_{nom}$ [mm]								
		50	50	70	90	50	50	70	70	90
<b>S11 Perforated clay brick</b> HLz acc. to EN 771-1:2011 e.g. <i>Schlagmann</i> <i>Poroton S10</i> 	6/0,7	-	-	-	-	-	-	1,5	-	-
	4/0,7	-	-	-	-	-	-	0,9	-	-
<b>10 DF (300x250x240)</b> rotary drilling										
<b>S12 Perforated clay brick</b> HLz acc. to EN 771-1:2011 e.g. <i>Schlagmann</i> <i>Poroton T8</i> 	4/0,6	-	-	-	-	-	-	1,2	-	-
	2/0,6	-	-	-	-	-	-	0,6	-	-
<b>12 DF (365x248x240)</b> rotary drilling										
<b>S13 Perforated clay brick</b> HLz acc. to EN 771-1:2011, e.g. <i>Hörl &amp; Hartmann</i> <i>Coriso WS 09</i> 	6/0,8	-	-	-	-	-	-	0,9	-	-
	4/0,8	-	-	-	-	-	-	0,6	-	-
	2/0,8	-	-	-	-	-	-	0,3	-	-
<b>(360x245x240)</b> rotary drilling										
Partial safety factor	$\gamma_{Mm}$ <sup>1)</sup>	2,5								

<sup>1)</sup> In absence of other national regulations.

fischer frame fixing SXR / SXRL

**Performances**

Characteristic resistance for use in hollow or perforated masonry

**Annex C 11**

**Table C12.1: Characteristic resistance  $F_{Rk}$  in [kN] in hollow or perforated masonry (use category "c")**

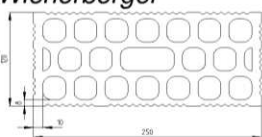
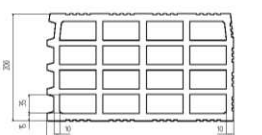
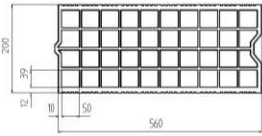
Base material [Supplier Title] Geometry, DF or nom. size (L x W x H) [mm] and drilling method	Min. compressive strength $f_b$ [N/mm <sup>2</sup> ] / bulk density $\rho$ [kg/dm <sup>3</sup> ]	Characteristic resistance $F_{Rk}$ [kN] 50/80°C								
		SXR 8	SXRL 8 <sup>7)</sup>		SXR 10	SXRL 10		SXRL 14 <sup>7)</sup>		
		h <sub>nom</sub> [mm]								
		50	50	70	90	50	50	70	70	90
<b>S14 Perforated clay brick</b> HLz acc. to EN 771-1:2011 <i>e.g. Doppio Uni IT</i> <i>Wienerberger</i>  (250x120x190) rotary drilling	20/0,9	-	1,2	0,9 1,5 <sup>2)</sup>	1,5 2,0 <sup>2)</sup>	-	-	-	-	-
	16/0,9	-	0,9	0,9 1,2 <sup>2)</sup>	1,2 1,5 <sup>2)</sup>	-	-	-	-	-
	12/0,9	-	0,75	0,6 0,75 <sup>2)</sup>	0,9 1,2 <sup>2)</sup>	-	-	-	-	-
<b>S15 Perforated clay brick</b> HLz acc. to EN 771-1:2011, <i>e.g. Imerys Gelimatic</i>  (500x200x270) rotary drilling	6/0,6	-	-	-	-	0,6 0,75 <sup>6)</sup>	-	1,5	-	-
	4/0,6	-	-	-	-	-	-	0,9	-	-
	2/0,6	-	-	-	-	-	-	0,5	-	-
<b>S16 Perforated clay brick</b> HLz acc. to EN 771-1:2011, <i>e.g. Imerys Optibric</i>  (560x200x275) rotary drilling	10/0,6	-	-	-	-	1,2	-	1,5	-	-
	8/0,6	-	-	-	-	-	-	1,2	-	-
	6/0,6	-	-	-	-	-	-	0,9	-	-
	4/0,6	-	-	-	-	-	-	0,6	-	-
Partial safety factor	$\gamma_{Mm}$ <sup>1)</sup>	2,5								

1) In absence of other national regulations.

2) Only valid for temperature range 30/50° C.

6) Only valid for edge distance  $c \geq 200$  mm for temperature range 30/50° C; intermediate values by linear interpolation.

7) The lowest load of two consecutive embedment depths may be used for the intermediate embedment depths.

fischer frame fixing SXR / SXRL

**Performances**

Characteristic resistance for use in hollow or perforated masonry

**Annex C 12**

**Table C13.1: Characteristic resistance  $F_{Rk}$  in [kN] in hollow or perforated masonry (use category “c”)**

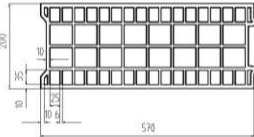
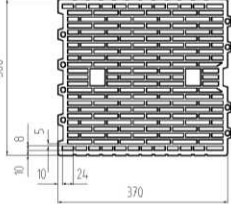
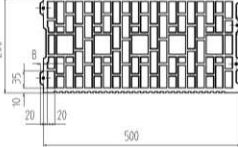
Base material [Supplier Title] Geometry, DF or nom. size (L x W x H) [mm] and drilling method	Min. compressive strength $f_b$ [N/mm <sup>2</sup> ] / bulk density $\rho$ [kg/dm <sup>3</sup> ]	Characteristic resistance $F_{Rk}$ [kN] 50/80°C								
		SXR 8	SXRL 8		SXR 10	SXRL 10		SXRL 14		
		h <sub>nom</sub> [mm]								
		50	50	70	90	50	50	70	70	90
<b>S17 Perforated clay brick</b> <b>HLz</b> acc. to EN 771-1:2011, e.g. <i>Bouyer Leroux BGV</i> (570x200x315)  rotary drilling	6/0,6	-	-	-	-	0,75 0,9 <sup>3)</sup> 1,2 <sup>5)</sup>	-	0,9	-	-
<b>S18 Perforated clay brick</b> <b>HLz</b> acc. to EN 771-1:2011, e.g. <i>Wienerberger Porotherm 30 R</i>  (370x300x250) rotary drilling	10/0,7	-	-	-	-	0,5 0,6 <sup>3)</sup>	-	-	-	-
<b>S19 Perforated clay brick</b> <b>HLz</b> acc. to EN 771-1:2011, e.g. <i>Wienerberger Porotherm GF R20</i>  (500x200x275) rotary drilling	10/0,7	-	-	-	-	0,6 0,75 <sup>3)</sup>	-	0,9	-	-
Partial safety factor $\gamma_{Mm}$ <sup>1)</sup>		2,5								

<sup>1)</sup> In absence of other national regulations.

<sup>3)</sup> Only valid for edge distance  $c \geq 150$  mm; intermediate values by linear interpolation.

<sup>5)</sup> Only valid for edge distance  $c \geq 150$  mm for temperature range 30/50° C; intermediate values by linear interpolation.

<sup>7)</sup> The lowest load of two consecutive embedment depths may be used for the intermediate embedment depths.

fischer frame fixing SXR / SXRL

**Performances**

Characteristic resistance for use in hollow or perforated masonry

**Annex C 13**

**Table C14.1: Characteristic resistance  $F_{Rk}$  in [kN] in hollow or perforated masonry (use category "c")**

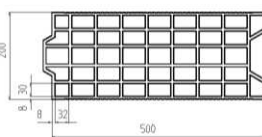
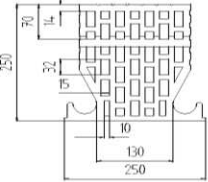
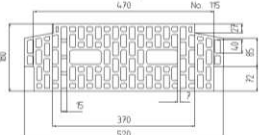
Base material [Supplier Title] Geometry, DF or nom. size (L x W x H) [mm] and drilling method	Min. com- pressive strength $f_b$ [N/mm <sup>2</sup> ] / bulk density $\rho$ [kg/dm <sup>3</sup> ]	Characteristic resistance $F_{Rk}$ [kN] 50/80°C								
		SXR 8	SXRL 8		SXR 10	SXRL 10		SXRL 14		
		$h_{nom}$ [mm]								
		50	50	70	90	50	50	70	70	90
<b>S20 Perforated clay brick</b> HLz acc. to EN 771-1:2011, e.g. <i>Terreal Calibric</i>  (500x200x220) rotary drilling	8/0,7	-	-	-	-	0,6 0,75 <sup>6)</sup>	-	0,9	-	-
	6/0,7	-	-	-	-	-	-	0,75	-	-
	4/0,7	-	-	-	-	-	-	0,4	-	-
<b>Perforated clay ceiling brick</b> acc. to DIN 4159:2014-05, e.g. <i>Hörl &amp; Hartmann ceiling block</i>  (250x250x190) rotary drilling	10/0,7	-	-	-	-	-	-	2,0	-	-
	8/0,7	-	-	-	-	-	-	1,5	-	-
	6/0,7	-	-	-	-	-	-	1,2	-	-
<b>Perforated clay ceiling brick</b> acc. to EN 15037-3:2011, e.g. <i>Hörl &amp; Hartmann block for beam-and-block ceilings</i>  (520x250x180) rotary drilling	8/0,7	-	-	-	-	-	-	1,5	-	-
	6/0,7	-	-	-	-	-	-	1,2	-	-
	4/0,7	-	-	-	-	-	-	0,9	-	-
Partial safety factor	$\gamma_{Mm}$ <sup>1)</sup>	2,5								

1) In absence of other national regulations.

6) Only valid for edge distance  $c \geq 200$  mm for temperature range 30/50°C; intermediate values by linear interpolation.

fischer frame fixing SXR / SXRL

**Performances**

Characteristic resistance for use in hollow or perforated masonry

Annex C 14

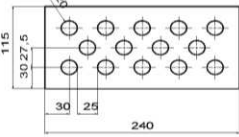
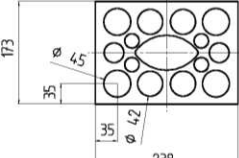
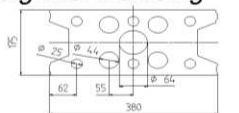

**Table C15.1: Characteristic resistance  $F_{Rk}$  in [kN] in hollow or perforated masonry (use category “c”)**

Base material [Supplier Title] Geometry, DF or nom. size (L x W x H) [mm] and drilling method	Min. compressive strength $f_b$ [N/mm <sup>2</sup> ] / bulk density $\rho$ [kg/dm <sup>3</sup> ]	Characteristic resistance $F_{Rk}$ [kN] 50/80°C								
		SXR 8	SXRL 8 <sup>7)</sup>			SXR 10	SXRL 10		SXRL 14 <sup>7)</sup>	
		h <sub>nom</sub> [mm]								
		50	50	70	90	50	50	70	70	90
<b>S23 Hollow calcium silicate brick KSL</b> acc. to EN 771-2:2011 e.g. KS Wemding  2 DF (240x115x113) hammer drilling	20/1,4	-	2,0	2,5	2,5	-	-	-	-	-
	12/1,4	2,0	1,2	1,5	1,5	2,0 2,5 <sup>2)</sup>	-	2,5	1,5 2,0 <sup>2)</sup>	2,5
	10/1,4	1,5	-	-	-	2,0	-	2,0	1,5	2,0
	8/1,4	1,2	-	-	-	1,5	-	1,5	1,2	1,5
	6/1,4	0,9	-	-	-	-	-	-	0,9	1,2
<b>S24 Hollow calcium silicate brick KSL</b> acc. to EN 771-2:2011 e.g. KS Wemding  3 DF (240x175x113) hammer drilling	20/1,4	1,2 1,5 <sup>2)</sup>	-	-	-	-	-	-	-	-
	16/1,4	0,9 1,2 <sup>2)</sup>	-	-	-	-	-	2,0	-	-
	12/1,4	0,75 0,9 <sup>2)</sup>	-	-	-	-	-	1,5	-	-
	10/1,4	0,6 0,75 <sup>2)</sup>	-	-	-	-	-	1,2	-	-
	8/1,4	0,5 0,6 <sup>2)</sup>	-	-	-	-	-	1,0	-	-
6/1,4	-	-	-	-	-	-	0,75	-	-	
<b>S25 Hollow calcium silicate brick KSL</b> acc. to EN 771-2:2011 e.g. KS Wemding  9 DF (380x175x240) hammer drilling	20/1,4	-	0,6 0,75 <sup>2)</sup>	1,5 2,0 <sup>2)</sup>	0,9 1,2 <sup>2)</sup>	-	-	3,5	3,5 4,0 <sup>2)</sup>	1,5 2,0 <sup>2)</sup>
	12/1,4	-	0,4 0,5 <sup>2)</sup>	0,9 1,2 <sup>2)</sup>	0,5 0,75 <sup>2)</sup>	-	-	2,0	2,0 2,5 <sup>2)</sup>	0,9 1,2 <sup>2)</sup>
	10/1,4	-	-	-	-	-	-	2,0	1,5 2,0 <sup>2)</sup>	0,75 0,9 <sup>2)</sup>
Partial safety factor	$\gamma_{Mm}$ <sup>1)</sup>	2,5								

1) In absence of other national regulations.

2) Only valid for temperature range 30/50° C.

7) The lowest load of two consecutive embedment depths may be used for the intermediate embedment depths.

fischer frame fixing SXR / SXRL

**Performances**

Characteristic resistance for use in hollow or perforated masonry

Annex C 15

**Table C16.1: Characteristic resistance  $F_{Rk}$  in [kN] in hollow or perforated masonry (use category “c”)**

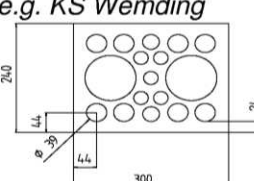
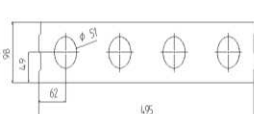
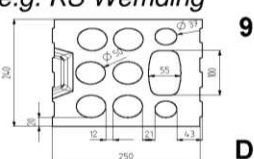
Base material [Supplier Title] Geometry, DF or nom. size (L x W x H) [mm] and drilling method	Min. compressive strength $f_b$ [N/mm <sup>2</sup> ] / bulk density $\rho$ [kg/dm <sup>3</sup> ]	Characteristic resistance $F_{Rk}$ [kN] 50/80°C								
		SXR 8	SXRL 8		SXR 10	SXRL 10		SXRL 14		
		$h_{nom}$ [mm]								
		50	50	70	90	50	50	70	70	90
<b>S26 Hollow calcium silicate brick KSL</b> acc. to EN 771-2:2011 e.g. <i>KS Wemding</i>  <b>5 DF (300x240x113)</b> hammer drilling	16/1,4	<b>2,0</b>	-	-	-	<b>3,0</b> <b>3,5<sup>5)</sup></b>	-	-	-	-
	12/1,4	<b>1,5</b>	-	-	-	-	-	-	-	-
	10/1,4	<b>1,2</b>	-	-	-	<b>1,5</b>	-	-	-	-
	8/1,4	<b>0,9</b>	-	-	-	-	-	-	-	-
	6/1,4	<b>0,75</b> <b>0,9<sup>2)</sup></b>	-	-	-	-	-	-	-	-
<b>S27 Hollow calcium silicate brick KSL</b> acc. to EN 771-2:2011 e.g. <i>KS Wemding, P10</i>  <b>(495x98x245)</b> hammer drilling	6/1,2	<b>1,2</b> <b>1,5<sup>2)</sup></b>	-	-	-	<b>1,5</b> <b>2,0<sup>3)</sup></b> <b>2,5<sup>5)</sup></b>	-	-	-	-
	4/1,2	<b>0,75</b> <b>0,9<sup>2)</sup></b>	-	-	-	-	-	-	-	-
	2/1,2	<b>0,4</b> <b>0,5<sup>2)</sup></b>	-	-	-	-	-	-	-	-
<b>S28 Hollow calcium silicate brick KSL</b> acc. to EN 771-2:2011 e.g. <i>KS Wemding</i>  <b>9 DF (250x240x240)</b> hammer drilling	12/1,4	-	-	-	-	-	-	<b>2,0</b>	-	-
	10/1,4	-	-	-	-	-	-	<b>1,5</b>	-	-
	8/1,4	-	-	-	-	-	-	<b>1,2</b>	-	-
	6/1,4	-	-	-	-	-	-	<b>0,9</b>	-	-
Partial safety factor	$\gamma_{Mm}$ <sup>1)</sup>	<b>2,5</b>								

1) In absence of other national regulations.

2) Only valid for temperature range 30/50° C.

3) Only valid for edge distance  $c \geq 150$  mm; intermediate values by linear interpolation.

5) Only valid for edge distance  $c \geq 150$  mm for temperature range 30/50° C; intermediate values by linear interpolation.

fischer frame fixing SXR / SXRL

**Performances**

Characteristic resistance for use in hollow or perforated masonry

**Annex C 16**

**Table C17.1: Characteristic resistance  $F_{Rk}$  in [kN] in hollow or perforated masonry (use category “c”)**

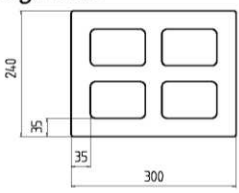
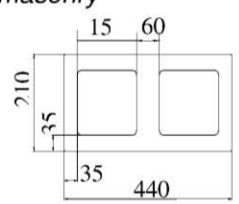
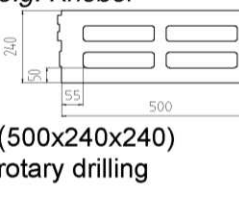
Base material [Supplier Title] Geometry, DF or nom. size (L x W x H) [mm] and drilling method	Min. compressive strength $f_b$ [N/mm <sup>2</sup> ] / bulk density $\rho$ [kg/dm <sup>3</sup> ]	Characteristic resistance $F_{Rk}$ [kN] 50/80°C								
		SXR 8	SXRL 8 <sup>7)</sup>			SXR 10	SXRL 10		SXRL 14 <sup>7)</sup>	
		h <sub>nom</sub> [mm]								
		50	50	70	90	50	50	70	70	90
<b>S29 Hollow brick light-weight concrete</b> <b>Hbl acc. to EN 771-3,</b> <i>e.g. KLB</i>  (300x240x240) hammer drilling	2/1,2	-	-	-	-	1,5	-	-	-	-
<b>S30 Hollow brick light-weight concrete</b> <b>Hbl acc. to EN 771-3,</b> <i>e.g. Roadstone masonry</i>  (440x210x215) hammer drilling	10/1,2	2,5	2,0	2,0 2,5 <sup>2)</sup>	0,4 0,6 <sup>2)</sup>	-	-	2,5	3,0	-
	8/1,2	2,0	1,5	1,5 2,0 <sup>2)</sup>	0,3 0,5 <sup>2)</sup>	2,5	-	2,0	2,5	-
	6/1,2	1,5	1,2	1,2 1,5 <sup>2)</sup>	0,3	2,0	-	1,5	2,0	-
	4/1,2	-	-	-	-	-	-	0,9	1,2	-
	2/1,2	-	-	-	-	-	-	0,5	0,6	-
<b>S31 Hollow brick light-weight concrete</b> <b>Hbl acc. to EN 771-3,</b> <i>e.g. Knobel</i>  (500x240x240) rotary drilling	6/0,8	-	1,5	2,5	1,5 2,0 <sup>2)</sup>	-	2,5	-	-	-
	4/0,8	-	0,9	1,5	0,9 1,2 <sup>2)</sup>	-	1,5	-	-	-
	2/0,8	-	0,5	0,75	0,5 0,6 <sup>2)</sup>	-	0,75	-	-	-
	2/0,7	-	1,5 2,0 <sup>2)</sup>	2,0 2,5 <sup>2)</sup>	1,5 2,0 <sup>2)</sup>	-	2,0 2,5 <sup>2)</sup>	2,5	1,2 1,5 <sup>2)</sup>	0,75
Partial safety factor	$\gamma_{Mm}$ <sup>1)</sup>	2,5								

1) In absence of other national regulations.

2) Only valid for temperature range 30/50° C.

7) The lowest load of two consecutive embedment depths may be used for the intermediate embedment depths.

fischer frame fixing SXR / SXRL

**Performances**

Characteristic resistance for use in hollow or perforated masonry

Annex C 17

**Table C18.1: Characteristic resistance  $F_{Rk}$  in [kN] in hollow or perforated masonry (use category "c")**

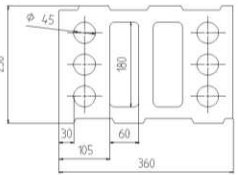
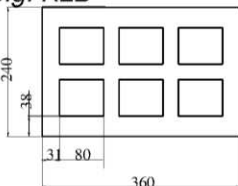
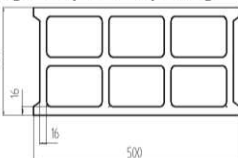
Base material [Supplier Title] Geometry, DF or nom. size (L x W x H) [mm] and drilling method	Min. compressive strength $f_b$ [N/mm <sup>2</sup> ] / bulk density $\rho$ [kg/dm <sup>3</sup> ]	Characteristic resistance $F_{Rk}$ [kN] 50/80°C								
		SXR 8	SXRL 8		SXR 10	SXRL 10		SXRL 14		
		h <sub>nom</sub> [mm]								
		50	50	70	90	50	50	70	70	90
<b>S32 Hollow brick light-weight concrete</b> <b>Hbl acc. to EN 771-3,</b> <i>e.g. KLB</i>  (360x250x250) hammer drilling	2/0,9	-	-	-	-	-	-	<b>0,75</b>	-	-
<b>S33 Hollow brick light-weight concrete</b> <b>Hbl acc. to EN 771-3:2011,</b> <i>e.g. KLB</i>  (360x240x240) hammer drilling	6/1,0	<b>1,5</b>	-	-	-	-	-	-	-	-
<b>S34 Hollow brick light-weight concrete</b> <b>Hbl acc. to EN 771-3:2011,</b> <i>e.g. Sepa Parpaing</i>  (500x200x200) rotary drilling	6/0,9	-	-	-	-	-	-	<b>0,5</b>	-	-
	4/0,9	<b>0,3</b> <b>0,4<sup>2)</sup></b>	-	-	-	<b>0,9</b> <b>1,2<sup>4)</sup></b> <b>1,5<sup>6)</sup></b>	-	<b>0,3</b>	-	-
Partial safety factor $\gamma_{Mm}$ <sup>1)</sup>		<b>2,5</b>								

1) In absence of other national regulations.

2) Only valid for temperature range 30/50° C.

4) Only valid for edge distance  $c \geq 200$  mm; intermediate values by linear interpolation.

6) Only valid for edge distance  $c \geq 200$  mm for temperature range 30/50° C; intermediate values by linear interpolation.

fischer frame fixing SXR / SXRL

**Performances**

Characteristic resistance for use in hollow or perforated masonry

**Annex C 18**

**Table C19.1: Characteristic resistance  $F_{Rk}$  in [kN] in hollow or perforated masonry (use category "c")**

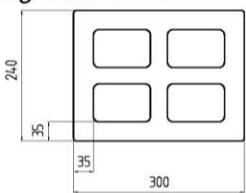
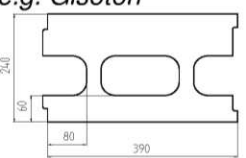
Base material [Supplier Title] Geometry, DF or nom. size (L x W x H) [mm] and drilling method	Min. compressive strength $f_b$ [N/mm <sup>2</sup> ] / bulk density $\rho$ [kg/dm <sup>3</sup> ]	Characteristic resistance $F_{Rk}$ [kN] 50/80°C									
		SXR 8	SXRL 8				SXR 10	SXRL 10		SXRL 14	
		h <sub>nom</sub> [mm]									
		50	50	70	90	50	50	70	70	90	
<b>S35 Hollow brick normal concrete Hbn</b> acc. to EN 771-3, <i>e.g. Adolf Blatt</i>  (300x240x240) hammer drilling	6/1,6	-	-	-	-	2,5	-	2,0	-	-	
	4/1,6	-	-	-	-	1,5	-	1,2	-	-	
	2/1,6	-	-	-	-	0,75	-	0,6	-	-	
<b>S36 Heat insulation brick WDB</b> <i>e.g. Gisoton</i>  (390x240x240) hammer drilling	2/0,7	-	-	-	-	1,5	-	-	-	-	
Partial safety factor $\gamma_{Mm}$ <sup>1)</sup>		2,5									

<sup>1)</sup> In absence of other national regulations.

fischer frame fixing SXR / SXRL

**Performances**

Characteristic resistance for use in hollow or perforated masonry

**Annex C 19**

**Table C20.1: Characteristic resistance  $F_{Rk}$  in [kN] in autoclaved aerated concrete (AAC), use category "d"**

Base material [Supplier Title] Geometry, DF or nom. size (L x W x H) [mm] and drilling method	Min. compressive strength $f_b$ [N/mm <sup>2</sup> ]	Characteristic resistance $F_{Rk}$ [kN] 50/80°C									
		SXR 8	SXRL 8		SXR 10	SXRL 10		SXRL 14			
		$h_{nom}$ [mm]									
		≥ 50	≥ 50	≥ 70	≥ 90	≥ 50	≥ 70	≥ 90	≥ 70	≥ 90	
Autoclaved aerated concrete, AAC acc. to EN 771-4:2011  e.g. (500x120x300) e.g. (500x250x300) hammer drilling	≥ 6	-	-	1,5 3,0 <sup>5)</sup>	2,0 3,0 <sup>5)</sup>	0,75 0,9 <sup>2)</sup>	2,0 2,5 <sup>6)</sup> 3,0 <sup>4)</sup>	2,5 3,0 <sup>6)</sup> 4,0 <sup>4)</sup>	4,0	5,0	
	≥ 4	-	-	0,9 1,5 <sup>5)</sup>	1,2 1,5 <sup>5)</sup>	0,75 0,9 <sup>2)</sup>	1,2 1,5 <sup>6)</sup> 2,0 <sup>4)</sup>	1,5 2,5 <sup>4)</sup>	2,5	3,0	
	≥ 3	-	-	0,6 0,9 <sup>5)</sup>	0,9 1,2 <sup>5)</sup>	0,4 <sup>3)</sup> 0,5 <sup>2)3)</sup>	0,9 1,2 <sup>4)</sup>	0,9 1,2 <sup>6)</sup> 1,5 <sup>4)</sup>	1,5	2,0	
	≥ 2	-	-	0,4	0,6	0,4 <sup>3)</sup> 0,5 <sup>2)3)</sup>	0,5 0,75 <sup>4)</sup>	0,6 0,9 <sup>4)</sup>	0,9	1,2	
Partial safety factor $\gamma_{MAAC}$ <sup>1)</sup>		2,0									

- 1) In absence of other national regulations.
- 2) Only valid for temperature range 30/50° C.
- 3) For the fixing in autoclaved aerated concrete with a nominal compressive strength  $f_{ck} < 4$  N/mm<sup>2</sup> the hole is made by using the accompanying AAC hole punch in accordance with Table C20.2.
- 4) Values valid for member thickness  $h_{min} \geq 175$  mm.
- 5) Only valid for edge distance  $c \geq 120$  mm.
- 6) Only valid for edge distance  $c \geq 180$  mm.

**Table C20.2: Assignment AAC hole punch type – anchor type (length) only for AAC  $f_b < 4$ N/mm<sup>2</sup> SXR 10**

Hole punch only for SXR 10 $h_{nom} = 50$ mm in AAC $f_b < 4$ N/mm <sup>2</sup>					Anchor type (length)
Type	$a_1$	$a_2$	b	l	
GBS 10 x 80	9	10	80	85	SXR 10 x 52 SXR 10 x 60 SXR 10 x 80
GBS 10 x 100				105	SXR 10 x 100
GBS 10 x 135			140	SXR 10 x 120	
GBS 10 x 160			165	SXR 10 x 140 SXR 10 x 160	
GBS 10 x 185			190	SXR 10 x 180	
GBS 10 x 230			235	SXR 10 x 200 SXR 10 x 230	

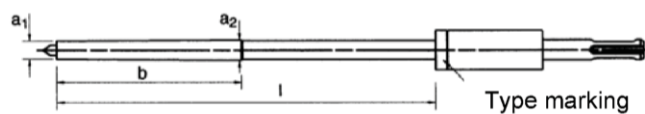

fischer frame fixing SXR / SXRL

**Performances**  
Characteristic resistance for use in autoclaved aerated concrete

**Annex C 20**